



33068 桃園縣桃園市興隆路18號  
TEL:886-3-3626301  
FAX:886-3-3716301

#### IABU Headquarters

**Delta Electronics, Inc.**  
Taoyuan Technology Center  
No.18, Xinglong Rd., Taoyuan City,  
Taoyuan County 33068, Taiwan  
TEL: 886-3-362-6301 / FAX: 886-3-371-6301

#### Asia

**Delta Electronics (Jiangsu) Ltd.**  
Wujiang Plant 3  
1688 Jiangxing East Road,  
Wujiang Economic Development Zone  
Wujiang City, Jiang Su Province,  
People's Republic of China (Post code: 215200)  
TEL: 86-512-6340-3008 / FAX: 86-769-6340-7290

**Delta Greentech (China) Co., Ltd.**  
238 Min-Xia Road, Pudong District,  
Shanghai, P.R.C.  
Post code: 201209  
TEL: 86-21-58635678 / FAX: 86-21-58630003

**Delta Electronics (Japan), Inc.**  
Tokyo Office  
2-1-14 Minato-ku Shibadaimon,  
Tokyo 105-0012, Japan  
TEL: 81-3-5733-1111 / FAX: 81-3-5733-1211

**Delta Electronics (Korea), Inc.**  
1511, Byucksan Digital Valley 6-cha, Gasan-dong,  
Geumcheon-gu, Seoul, Korea, 153-704  
TEL: 82-2-515-5303 / FAX: 82-2-515-5302

**Delta Electronics Int'l (S) Pte Ltd**  
4 Kaki Bukit Ave 1, #05-05, Singapore 417939  
TEL: 65-6747-5155 / FAX: 65-6744-9228

**Delta Electronics (India) Pvt. Ltd.**  
Plot No 43 Sector 35, HSIIDC  
Gurgaon, PIN 122001, Haryana, India  
TEL: 91-124-4874900 / FAX: 91-124-4874945

#### Americas

**Delta Products Corporation (USA)**  
Raleigh Office  
P.O. Box 12173, 5101 Davis Drive,  
Research Triangle Park, NC 27709, U.S.A.  
TEL: 1-919-767-3800 / FAX: 1-919-767-8080

**Delta Greentech (Brasil) S.A**  
Sao Paulo Office  
Rua Itapeva, 26 - 3º andar Edifício Itapeva One-Bela Vista  
01332-000-São Paulo-SP-Brazil  
TEL: +55 11 3568-3855 / FAX: +55 11 3568-3865

#### Europe

**Deltronics (The Netherlands) B.V.**  
Eindhoven Office  
De Witbogt 15, 5652 AG Eindhoven, The Netherlands  
TEL: 31-40-2592850 / FAX: 31-40-2592851



中达电通股份有限公司

上海市浦東新區民夏路238號, 201209  
公司網址: [www.deltagreentech.com.cn](http://www.deltagreentech.com.cn)

北京: 010-8225-3225  
太原: 0351-4039-485  
长春: 0431-8859-6018  
长沙: 0731-8827-7881  
成都: 028-8434-2072  
天津: 022-2301-5082  
重庆: 023-8806-0306  
广州: 020-3879-2175  
哈尔滨: 0451-53665568  
杭州: 0571-8882-0610  
合肥: 0551-2816-777  
济南: 0531-8690-6277  
南昌: 0791-8625-5010  
南京: 025-8334-6585  
上海: 021-6301-2827  
沈阳: 024-2334-1159  
武汉: 027-8544-8475  
西安: 029-8669-0810  
厦门: 0592-5313-601  
郑州: 0371-6384-2772  
南宁: 0771-5875-699  
乌鲁木齐: 0991-611-8160

\* We reserve the right to change the information in this manual without prior notice

\* 規格若有變更, 以實際產品為主

\* 規格若有變更, 以实际产品为主

5011665708  
2012-02-24



HB08

# DOP-B

## Quick Start Kullanım Kilavuzu

安 裝 手 冊  
安 裝 手 冊

High Color / Wide Screen / User-friendly HMI Products  
Yüksek Renk / Geniş Ekran / Kullanıcı Dostu HMI Ürünleri

高彩 / 寬螢幕 / 友善人機介面

高彩 / 宽屏幕 / 友善人机接口



Thank you for purchasing DELTA's DOP-B series. This quick start will be helpful in the installation, wiring and inspection of Delta HMI. Before using the product, please read this quick start to ensure correct use. You should thoroughly understand all safety precautions before proceeding with the installation, wiring and operation. Place this quick start in a safe location for future reference. Please observe the following precautions:

- Install the product in a clean and dry location free from corrosive and inflammable gases or liquids.
- Ensure that all wiring instructions and recommendations are followed.
- Ensure that HMI is correctly connected to a ground. The grounding method must comply with the electrical standard of the country (Please refer to NFPA 70: National Electrical Code, 2005 Ed.).
- Do not modify or remove wiring when power is applied to HMI.
- Do not touch the power supply during operation. Otherwise, it may cause electric shock.
- For the information of HMI software operation, and software installation, please refer to the HMI software manual.

If you have any questions during operation, please contact our local distributors or Delta sales representative.

The content of this quick start may be revised without prior notice. Please consult our distributors or download the most updated version at <http://www.delta.com.tw/industrialautomation>.

## Safety Precautions

Carefully note and observe the following safety precautions when receiving, inspecting, installing, operating, maintaining and troubleshooting. The following words, DANGER, WARNING and STOP are used to mark safety precautions when using the Delta's HMI product. Failure to observe these precautions may void the warranty!

### Installation



DANGER

- Comply with quick start for installation. Otherwise it may cause equipment damage.
- Do not install the product in a location that is outside the stated specification for the HMI. Failure to observe this caution may result in electric shock, fire, or explosion.
- Do not install the product in a location where temperatures will exceed specification for the HMI. Failure to observe this caution may result in abnormal operation or damage the product.
- Please note that this equipment has obtained EMC registration for commercial use. In the event that it has been mistakenly sold or purchased, please exchange it for equipment certified for home use.
- Do not use this product as an alarm device for disaster early warning that may result in personal injury, equipment damage, or system emergency stop.

### Wiring



DANGER

- Connect the ground terminals to a class-3 ground (Ground resistance should not exceed 100Ω). Improper grounding may result in communication error, electric shock or fire.

## Operation



- The users should use Delta Screen Editor software to perform editing in Delta's HMI product. To perform editing and confirming HMI programs without using Delta Screen Editor software in Delta's HMI product may result in abnormal operation.
- To prevent the personal injury and equipment damage, when designing HMI programs, please ensure that a communication error occurred between Delta's HMI product and the connecting controller or equipment will not result in system failure or malfunction.
- Please be sure to backup the screen data and HMI programs in case they are lost, accidentally deleted or worse.



- Do not modify wiring during operation. Otherwise it may result in electric shock or personal injury.
- Never use a hard or pointed object to hit or strike the screen as doing this may damage the screen and let the screen has not respond at all, and then cause HMI to work abnormally.

## Maintenance and Inspection



- Do not touch any internal or exposed parts of the HMI as electrical shock may result.
- Do not remove operation panel while power is on. Otherwise electrical shock may result.
- Wait at least 10 minutes after power has been removed before touching any HMI terminals or performing any wiring and/or inspection as an electrical charge may still remain in the HMI with hazardous voltages even after power has been removed.
- Turn the power off before changing backup battery and check system settings after finishing change. (all data will be cleared after changing battery).
- Be sure the ventilation holes are not obstructed during operation. Otherwise malfunction may result due to bad ventilation or overheating troubles.

## Wiring Method



- Do not use a voltage that will exceed specification for the HMI. Failure to observe this caution may result in electric shock or fire.
- Remove the terminal block from the HMI before wiring.
- Insert only one wire into one terminal on the terminal block.
- If the wiring is in error, perform the wiring again with proper tools. Never use force to remove the terminals or wires. Otherwise, it may result in malfunction or damage.
- For the power line that forced to take out, ensure to check wiring again and restart.

## Communication Wiring



- Comply with communication wiring specification for wiring.
- Wiring length should comply with the stated specification for the HMI.
- Proper grounding to avoid bad communication quality.
- To avoid noise and interference, the communication cable, all power cables, and motor power cable should be placed in separate conduits.

## Installation and Storage Conditions

The product should be kept in the shipping carton before installation. In order to retain the warranty coverage, the HMI should be stored properly when it is not to be used for an extended period of time. Some storage suggestions are:

- Store in a clean and dry location free from direct sunlight.
- Store within an ambient temperature range of -20°C to +60°C (-4°F to 140°F).

- Store within a relative humidity range of 10% to 90% and non-condensing.
- Do not store the HMI in a place subjected to corrosive gases and liquids.
- Correctly packaged and placed on a solid and durable surface.
- Do not mount the HMI adjacent to heat-radiating elements or in direct sunlight.
- Do not mount the HMI in a location subjected to corrosive gases, liquids, or airborne dust or metallic particles.
- Do not mount the HMI in a location where temperatures and humidity will exceed specification.
- Do not mount the HMI in a location where vibration and shock will exceed specification.
- Do not mount the HMI in a location where it will be subjected to high levels of electromagnetic radiation.

## Installation

### Installation Notes

- Improper installation will result in malfunction and greatly reduce the life of the HMI. Be sure to follow the guidelines in this quick start when installing the HMI.
- In order to ensure the HMI being well ventilated, make sure that the ventilation holes are not obstructed and must provide sufficient free space around HMI.
- To ensure the panel is well protected, be sure to install a waterproof gasket into HMI.
- For use on a flat surface of a Type 4X "Indoor Use Only" enclosure or equivalent.
- The allowable thickness of the panel for mounting should be less than 5 mm.

### Installation Method:

#### Step 1:

Ensure to put waterproof gasket into HMI and then insert the HMI into the panel cutout.

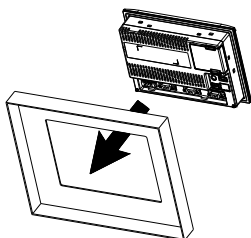

#### Step 2:

Ensure to insert fasteners into the HMI's insertion slots and turn the screw till screws touch panel cutout.

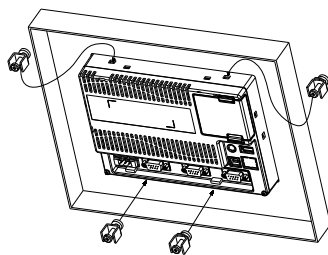

#### Step 3:

Turn the screw with less than torque 0.7N.M to avoid damage to plastic box.  
Torque: 6.17lb-inch (0.7N-M)

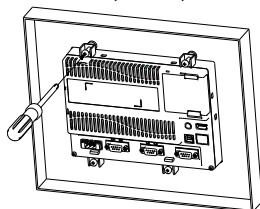

#### Step 4:

Keep at least 60mm distance from rear of HMI product to the wall, installation surface or the other controllers for heat dissipation.

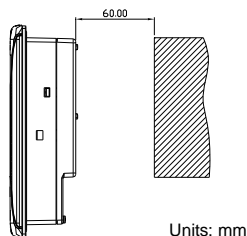

The size of the fastener.

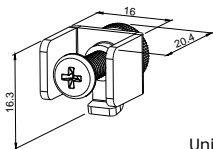

Units: mm

## Wiring

Please observe the following wiring notes while performing wiring.

### Wiring Notes

- To prevent electric shock, do not change wiring when the power is connected and has not been turned off.
- Because there is no power switch on the HMI, ensure that an interrupter switch is attached on its power cable.
- Please use shielded twisted-pair cables for wiring.

Recommended wiring is in the table below:

Type	Wire Gauge (AWG)	Stripped length	Torque
Solid	28 ~ 12	7 ~ 8 mm	5 kg-cm (4.3 lb-in)
Stranded	30 ~ 12	7 ~ 8 mm	5 kg-cm (4.3 lb-in)

Be sure to perform wiring by referring to the following figure (power supply connector).

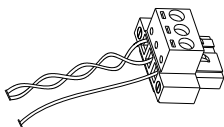

## Basic Inspection

Item	Content
General Inspection	<ul style="list-style-type: none"> <li>■ Periodically inspect the screws of the connection between the HMI and device. Tighten screws as necessary as they may loosen due to vibration and varying temperatures.</li> <li>■ Ensure that oil, water, metallic particles or any foreign objects do not fall inside the HMI, control panel or ventilation slots and holes. As these will cause damage.</li> <li>■ Ensure the correct installation and the control panel. It should be free from airborne dust, harmful gases or liquids.</li> </ul>
Inspection before operation (power is not applied)	<ul style="list-style-type: none"> <li>■ Ensure that all wiring terminals are correctly insulated.</li> <li>■ Ensure that all wiring is correct or damage and or malfunction may result.</li> <li>■ Visually check to ensure that there are not any unused screws, metal strips, any conductive or inflammable materials inside HMI.</li> <li>■ Ensure to lower electromagnetic interference when devices are influenced by it.</li> <li>■ Ensure that the external applied voltage to HMI is correct and matched to the controller.</li> </ul>
Inspection before operation (power is applied)	<ul style="list-style-type: none"> <li>■ Check if power LED lights.</li> <li>■ Check if the communication among devices is normal.</li> <li>■ Please contact our local distributors or Delta sales representative if there are any abnormal conditions.</li> </ul>

## Pin Definition of Serial Communication

DOP-B07S(E)415 / DOP-B07PS415 / DOP-B08S(E)515 / DOP-B10S(E)615 Series

### COM1 Port (Supports Flow Control)

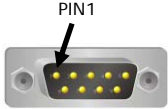
COM Port	PIN	Contact
		RS-232
	1	
	2	RXD
	3	TXD
	4	
	5	GND
	6	
	7	RTS
	8	CTS
	9	

Note: Blank = No Connection.

### COM2 Port (Supports Flow Control)

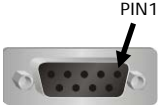
COM Port	PIN	MODE1	MODE2	MODE3
		RS-232	RS-422	RS-485
	1		TXD+	D+
	2	RXD		
	3	TXD		
	4		RXD+	
	5	GND	GND	GND
	6		TXD-	D-
	7	RTS		
	8	CTS		
	9		RXD-	

Note1: Blank = No Connection.

Note2: When COM2 port is used for RS-232 flow control, i.e. RTS and CTS signals are used for flow control, COM3 port will become incapable of being used.

Note3: When COM2 port is used for RS-422 flow control, please refer to the following COM3 Port signals table for pin assignments. The signals, RTS+, CTS+, RTS- and CTS- shown in brackets are the signals used for flow control.

### COM3 Port

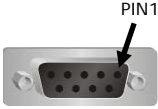
COM Port	PIN	MODE1	MODE2	MODE3
		RS-232	RS-422	RS-485
	1		TXD+(RTS+)	D+
	2	RXD		
	3	TXD		
	4		RXD+(CTS+)	
	5	GND	GND	GND
	6		TXD-(RTS-)	D-
	7			
	8			
	9		RXD-(CTS-)	

Note1: Blank = No Connection.

Note2: When COM2 port is used for RS-422 flow control, please refer to the COM3 Port signals table above for pin assignments. The signals, RTS+, CTS+, RTS- and CTS- shown in brackets are the signals used for flow control.

## Ethernet Interface (LAN)

Ethernet Interface (LAN)	PIN	Contact
		Ethernet
	1	TX+
	2	TX-
	3	RX+
	4	
	5	
	6	RX-
	7	
	8	

Note: Blank = No Connection.

## DOP-B05 / DOP-B07S(E)515 / DOP-B07PS515 Series

### COM1 Port (Supports Flow Control)

COM Port	PIN	Contact
		RS-232
	1	
	2	RXD
	3	TXD
	4	
	5	GND
	6	
	7	RTS
	8	CTS
	9	

Note: Blank = No Connection.

### COM2 and COM3 Port

COM Port	PIN	MODE1		MODE2		MODE3	
		COM2	COM3	COM2	COM3	COM2	COM3
		RS-232	RS-485	RS-485	RS-485	RS-232	RS-422
	1			D+			TXD+
	2	RXD				RXD	
	3	TXD				TXD	
	4		D+		D+		RXD+
	5		GND		GND		GND
	6			D-			TXD-
	7						
	8						
	9		D-		D-		RXD-

Note1: Blank = No Connection.

Note2: B05 / B07S(E)515/ B07PS515 series models do not support RS-422 flow control function.

## Parts Names

### DOP-B05S100 / DOP-B05S101 (Front View)

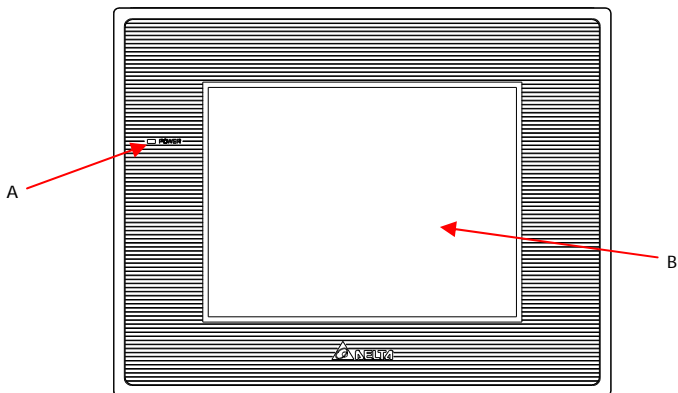

- |   |  |
|---|--|
| A | Power LED Indicator (Lights in green when HMI works normally.) |
| B | Touch Screen / Display   |

### DOP-B05S100 / DOP-B05S101 (Rear View)

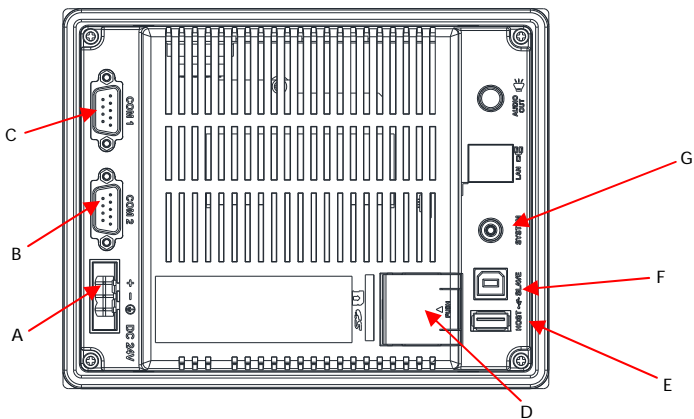

- |   |  |   |            |
|---|--|---|------------|
| A | Power Input Terminal                               | E | USB Host   |
| B | COM2 (can be extended to COM3 <sup>(Note1)</sup> ) | F | USB Client |
| C | COM1   | G | System Key |
| D | Battery Cover                                      | - | -          |



1. For the setting method, please refer to the pin definition of serial communication.



## DOP-B07S(E)515 / DOP-B07PS515 (Front View)

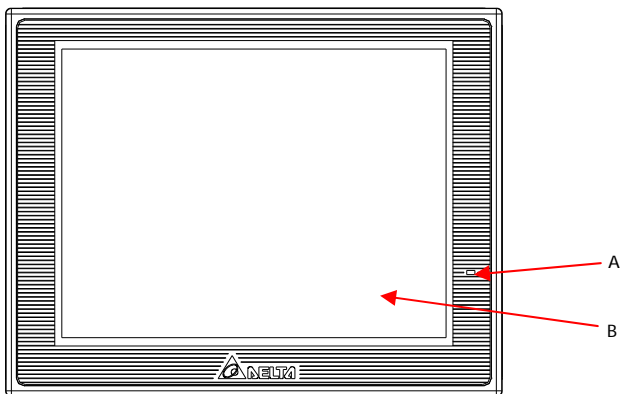

- |   |  |
|---|--|
| A | Power LED Indicator (Lights in green when HMI works normally.) |
| B | Touch Screen / Display   |

## DOP-B07S(E)515 / DOP-B07PS515 (Rear View)

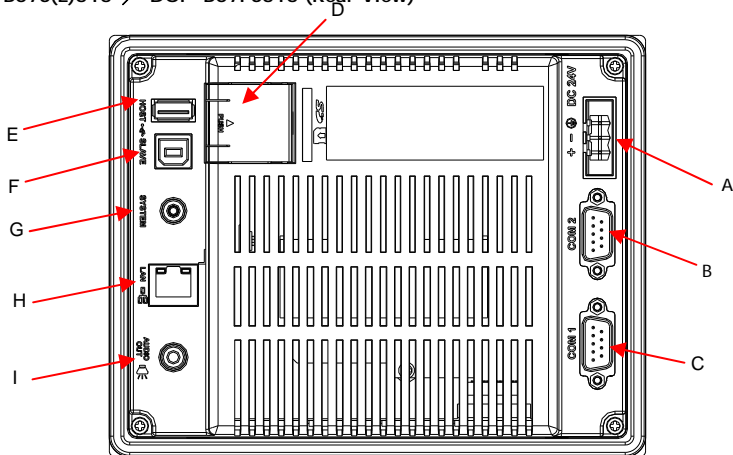



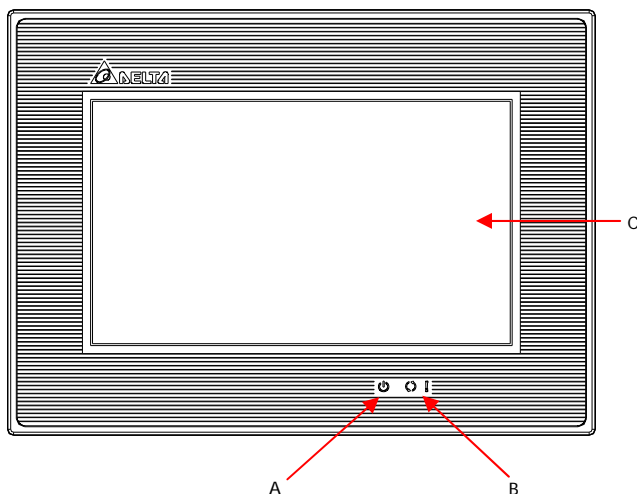

A	Power Input Terminal	F	USB Client
B	COM2 (can be extended to COM3 <sup>(Note1)</sup> )	G	System Key
C	COM1	H	Ethernet Interface (LAN)
D	Memory Card Slot / Battery Cover	I	Audio Output Interface
E	USB Host	-	-

### NOTE

1. For the setting method, please refer to the pin definition of serial communication.



A	 : Power LED Indicator Lights in green when HMI works normally.
C	 : Operation LED Indicator (Blue) <sup>(Note1)</sup> The operation LED indicator blinks in blue when either the communication is carried out or the data is accessing (please refer to the “Note1” below for explanation).  : Alarm LED Indicator (Red) The alarm LED indicator blinks in red when one of the alarms is on.
D	Touch Screen / Display
 <b>NOTE</b> 1. The definition of the operation LED indicator (Blue) can be determined by the users freely.	



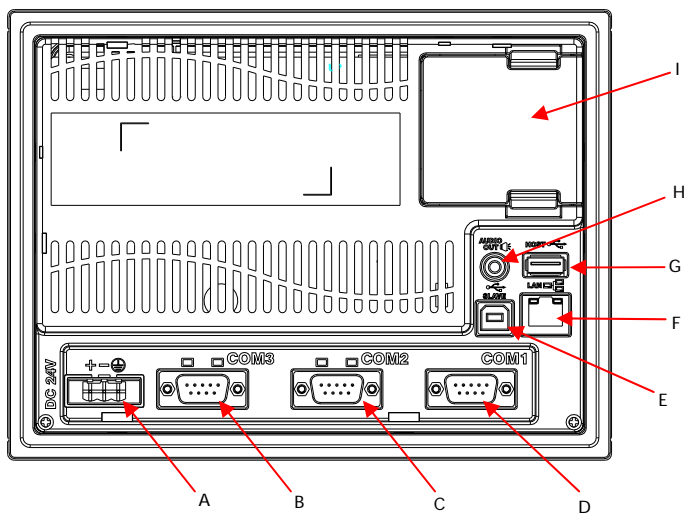

DOP-B07S(E)415 / DOP-B07PS415 (Rear View)

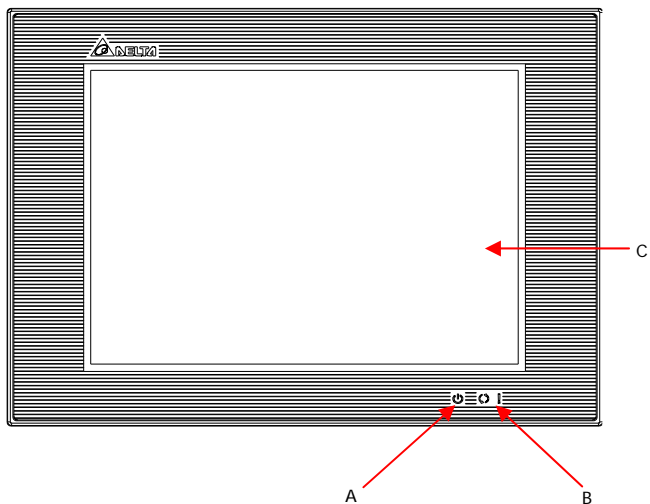

A	Power Input Terminal
B	COM3 (It is provided with two LED indicators to indicate that HMI is in Read or Write status during the communication process.)
C	COM2 (It is provided with two LED indicators to indicate that HMI is in Read or Write status during the communication process.)
D	COM1
E	USB Client
F	Ethernet Interface (LAN)
G	USB Host
H	Audio Output Interface
I	Memory Card Slot / Battery Cover

## DOP-B08S(E)515 (Front View)



A	 : Power LED Indicator Lights in green when HMI works normally.
B	 : Operation LED Indicator (Blue) <small>(Note1)</small> The operation LED indicator blinks in blue when either the communication is carried out or the data is accessing (please refer to the "Note1" below for explanation).  : Alarm LED Indicator (Red) The alarm LED indicator blinks in red when one of the alarms is on.
C	Touch Screen / Display
 <b>NOTE</b> 1. The definition of the operation LED indicator (Blue) can be determined by the users freely.	

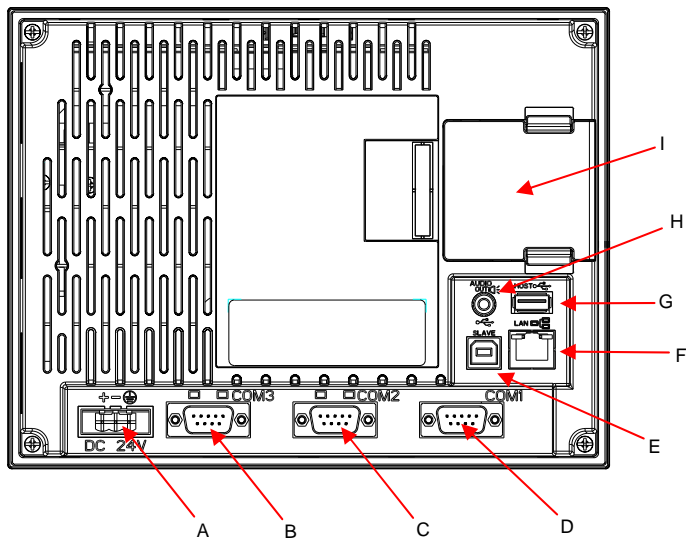

## DOP-B08S(E)515 (Rear View)

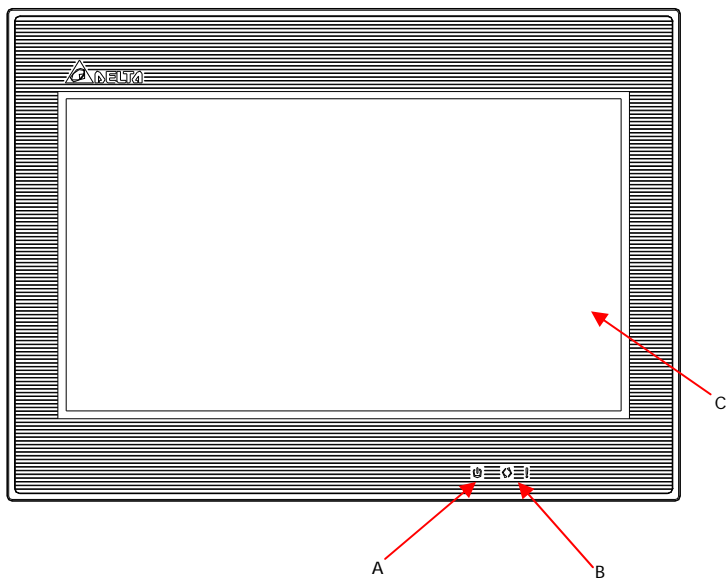

A	Power Input Terminal
B	COM3 (It is provided with two LED indicators to indicate that HMI is in Read or Write status during the communication process.)
C	COM2 (It is provided with two LED indicators to indicate that HMI is in Read or Write status during the communication process.)
D	COM1
E	USB Client
F	Ethernet Interface (LAN)
G	USB Host
H	Audio Output Interface
I	Memory Card Slot / Battery Cover

## DOP-B10S(E)615 (Front View)



A	 : Power LED Indicator Lights in green when HMI works normally.
B	 : Operation LED Indicator (Blue) <sup>(Note1)</sup> The operation LED indicator blinks in blue when either the communication is carried out or the data is accessing (please refer to the “Note1” below for explanation).  : Alarm LED Indicator (Red) The alarm LED indicator blinks in red when one of the alarms is on.
C	Touch Screen / Display

 **NOTE**

1. The definition of the operation LED indicator (Blue) can be determined by the users freely.

## DOP-B10S(E)615 (Rear View)

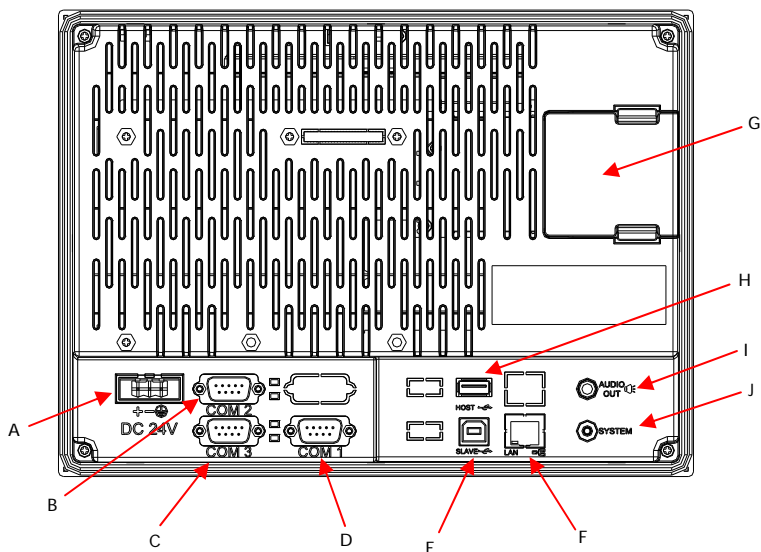

A	Power Input Terminal
B	COM2 (It is provided with two LED indicators to indicate that HMI is in Read or Write status during the communication process.)
C	COM3 (It is provided with two LED indicators to indicate that HMI is in Read or Write status during the communication process.)
D	COM1
E	USB Client
F	Ethernet Interface (LAN)
G	Memory Card Slot / Battery Cover
H	USB Host
I	Audio Output Interface
J	System Key

## Panel Cut-out

DOP-B05S100 / DOP-B05S101

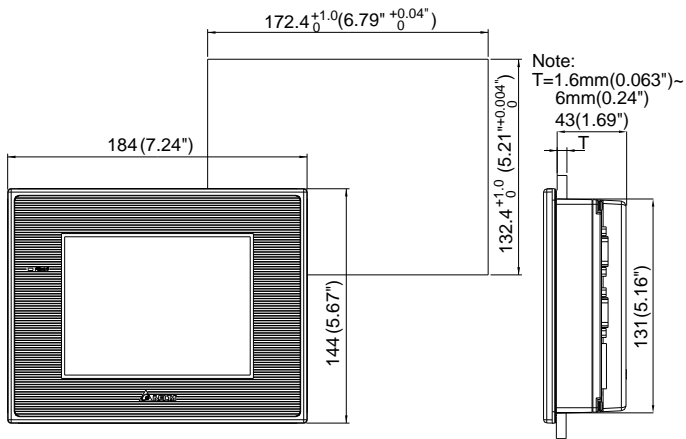

Units: mm (inches)

DOP-B07S(E)415 / DOP-B07PS415

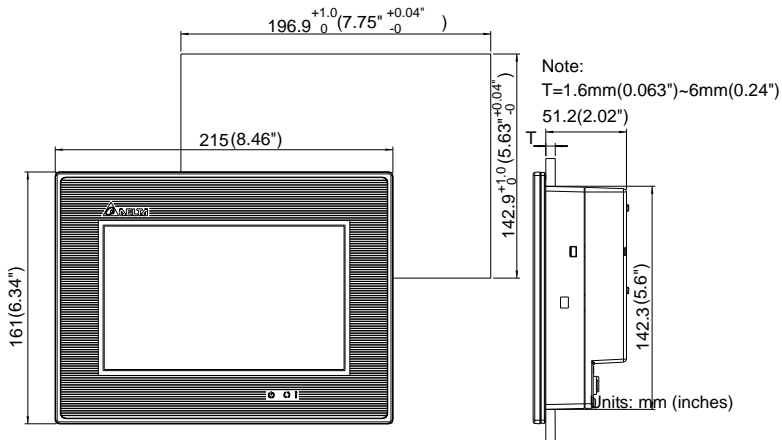

Units: mm (inches)

Units: mm (inches)



DOP-B07S(E)515 / DOP-B07PS515

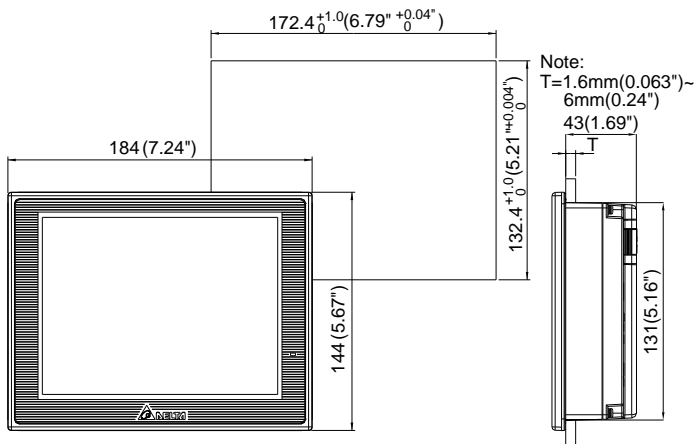

Units: mm (inches)

DOP-B08S(E)515

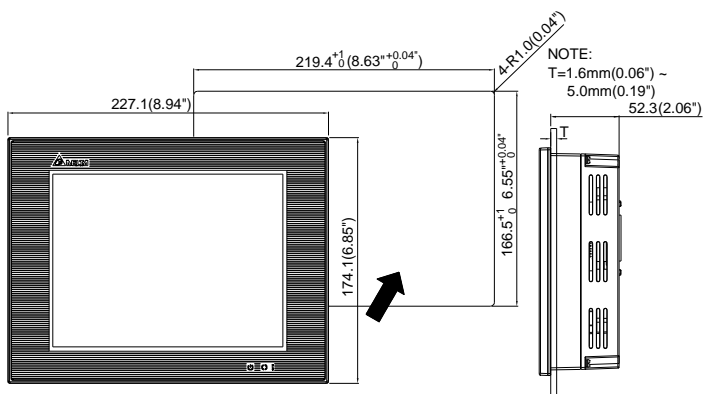

Units: mm (inches)

DOP-B10S(E)615

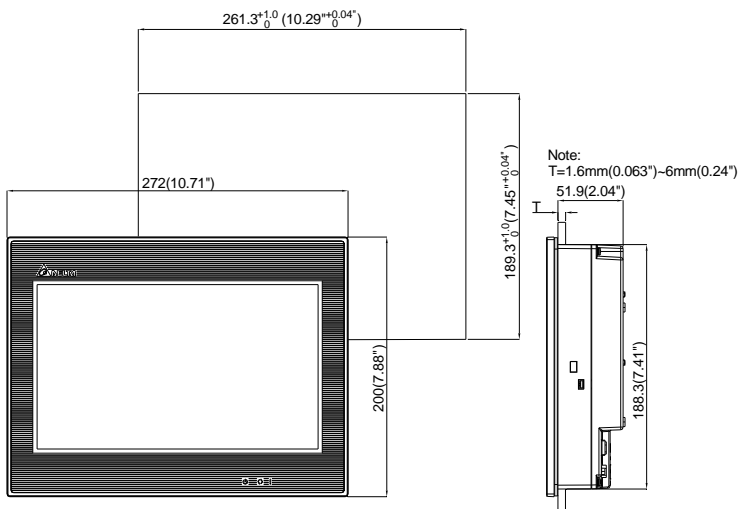

Units: mm (inches)

## Specifications

MODEL		B05S100	B05S101	B07S415	B07E415	B07PS415
LCD MODULE	Display Type	5.6" TFT LCD (65536 colors)		7" Widescreen TFT LCD (65536 colors)		
	Resolution	320 x 234 pixels		800 x 480 pixels		
	Backlight	LED Back Light (less than 20,000 hours half-life at 25°C) <sup>(Note 1)</sup>				
	Display Size	113.28 x 84.70mm		152.4 x 91.44mm		
Operation System		Delta Real Time OS				
MCU		32-bit RISC Micro-controller				
NOR Flash ROM		Flash ROM 4 MB(OS System: 2MB / User Application: 2MB)	Flash ROM 8 MB(OS System: 2MB / User Application: 6MB)	Flash ROM 128 MB (OS System: 30MB / Backup: 16MB / User Application: 82MB)		
SDRAM		8Mbytes	16Mbytes	64Mbytes		
Backup Memory		128Kbytes		16Mbytes		
Sound Effect Output	Buzzer	Multi-Tone Frequency ( 2K ~ 4K Hz ) / 85dB				
	AUX	N/A	N/A	N/A	Stereo output	N/A
Ethernet Interface		N/A	N/A	N/A	IEEE 802.3, IEEE 802.3u 10/100 Mbps auto-sensing (has built-in isolated power circuit <sup>(Note 3)</sup> )	N/A
Memory Card		N/A	N/A	SD Card (supports SDHC)		
USB		1 USB Host <sup>(Note 2)</sup> Ver 1.1 / 1 USB Slave Ver 1.1		1 USB Host <sup>(Note 2)</sup> Ver 2.0 / 1 USB Slave Ver 1.1		
Serial COM Port	COM1	RS-232 (supports hardware flow control)				
	COM2	RS-232 / RS-485		RS-232 / RS-422 / RS-485	RS-232 / RS-422 / RS-485 (has built-in isolated power circuit <sup>(Note 3)</sup> )	RS-232 / RS-422 / RS-485
	COM3	RS-422 / RS-485		RS-232 / RS-422 / RS-485	RS-232 / RS-422 / RS-485 (has built-in isolated power circuit <sup>(Note 3)</sup> )	RS-232 / RS-422 / RS-485
Function Key		N/A				
Perpetual Calendar (RTC)		Built-in				

MODEL	B05S100	B05S101	B07S415	B07E415	B07PS415
Cooling Method	Natural air circulation				
Safety Approval	CE / UL <sup>(Note 4)</sup> / KCC <sup>(Note 4)</sup>				
Waterproof Degree	IP65 / NEMA4				
Operation Voltage <sup>(Note 5)</sup>	DC +24V ( -10% ~ +15% ) (please use isolated power supply)	DC +24V ( -10% ~ +15% ) (please use isolated power supply)	DC +24V ( -10% ~ +15% ) ( has built-in isolated power circuit <sup>(Note 3)</sup> )	DC +24V ( -10% ~ +15% ) (please use isolated power supply)	
Voltage Endurance	AC500V for 1 minute (between charging (DC24V terminal) and FG terminals)				
Power Consumption <sup>(Note 5)</sup>	3.0W	5W	7.5W	5W	
Backup Battery	3V lithium battery CR2032 x 1				
Backup Battery Life	It depends on the temperature used and the conditions of usage, about 3 years or more at 25°C.				
Operation Temp.	0°C ~ 50°C				
Storage Temp.	-20°C ~ +60°C				
Ambient Humidity	10% ~ 90% RH [0 ~ 40°C], 10% ~ 55% RH [41 ~ 50°C] Pollution Degree 2				
Vibration Resistance	IEC 61131-2 Compliant 5Hz ≤ f < 9Hz = Continuous: 1.75mm / Occasional: 3.5mm 9Hz ≤ f ≤ 150Hz = Continuous: 0.5g / Occasional: 1.0g X, Y, Z directions for 10 times				
Dimensions (W) x (H) x (D) mm	184 x 144 x 50		215 x 161 x 50		
Panel Cutout (W) x (H) mm	172.4 x 132.4		196.9 x 142.9		
Weight	Approx. 670g		Approx. 970g		

## NOTE

- 1) The half-life of backlight is defined as original luminance being reduced by 50% when the maximum driving current is supplied to HMI. The life of LED backlight shown here is an estimated value under 25°C normal temperature and humidity conditions.
- 2) USB Host port can provide up to 5V/ 500mA of power.
- 3) The withstand voltage of the isolated power circuit is 1500V peak for 1 minute.
- 4) Some models are in the process of application to UL and KCC certification. For more information, please consult our distributors.
- 5) The value of the power consumption indicates the electrical power consumed by HMI only without connecting to any peripheral devices. In order to ensure the normal operation, it is recommended to use a power supply which the capacity is 1.5 ~ 2 times the value of the power consumption.
- 6) Users can download the DOPSoft software, the program editor of Delta HMI product and the user manual via the following link: <http://www.delta.com.tw/industrialautomation/>.
- 7) The content of this quick start may be revised without prior notice. Please consult our distributors or download the most updated version at <http://www.delta.com.tw/industrialautomation/>.

MODEL		B07S515	B07E515	B07PS515	B08S515	B08E515	B10S615	B10E615
LCD MODULE	Display Type	7" TFT LCD (65536 colors)			8" TFT LCD (65536 colors)		10.1" Widescreen TFT LCD (65536 colors)	
	Resolution	800 x 600 pixels			800 x 600 pixels		1024 x 600 pixels	
	Backlight	LED Back Light (less than 10,000 hours half-life at 25°C) <sup>(Note 1)</sup>						
	Display Size	141 x 105.75mm			162 x 121.5mm		226 x 128.7mm	
Operation System	Delta Real Time OS							
MCU	32-bit RISC Micro-controller							
NOR Flash ROM	Flash ROM 128 MB(OS System: 30MB / Backup: 16MB / User Application: 82MB)							
SDRAM	64Mbytes							
Backup Memory	16Mbytes							
Sound Effect Output	Buzzer	Multi-Tone Frequency ( 2K ~ 4K Hz ) / 85dB						
	AUX	N/A	Stereo output	N/A	N/A	Stereo output	N/A	Stereo output
Ethernet Interface	N/A	IEEE 802.3, IEEE 802.3u	N/A	N/A	IEEE 802.3, IEEE 802.3u	N/A	IEEE 802.3, IEEE 802.3u	
		10/100 Mbps auto-sensing (has built-in isolated power circuit <sup>(Note 3)</sup> )			10/100 Mbps auto-sensing (has built-in isolated power circuit <sup>(Note 3)</sup> )		10/100 Mbps auto-sensing (has built-in isolated power circuit <sup>(Note 3)</sup> )	
Memory Card	SD Card (supports SDHC)							
USB	1 USB Host <sup>(Note 2)</sup> Ver 2.0 / 1 USB Slave Ver 1.1							
Serial COM Port	COM1	RS-232 (supports hardware flow control)						
	COM2	RS-232 / RS-485	RS-232 / RS-485 (has built-in isolated power circuit <sup>(Note 3)</sup> )	RS-232 / RS-485	RS-232 / RS-422 / RS-485	RS-232 / RS-422 / RS-485 (has built-in isolated power circuit <sup>(Note 3)</sup> )	RS-232 / RS-422 / RS-485	RS-232 / RS-422 / RS-485 (has built-in isolated power circuit <sup>(Note 3)</sup> )
	COM3	RS-422 / RS-485	RS-422 / RS-485 (has built-in isolated power circuit <sup>(Note 3)</sup> )	RS-422 / RS-485	RS-232 / RS-422 / RS-485	RS-232 / RS-422 / RS-485 (has built-in isolated power circuit <sup>(Note 3)</sup> )	RS-232 / RS-422 / RS-485	RS-232 / RS-422 / RS-485 (has built-in isolated power circuit <sup>(Note 3)</sup> )
Function Key	N/A							
Perpetual Calendar (RTC)	Built-in							
Cooling Method	Natural air circulation							

MODEL	B07S515	B07E515	B07PS515	B08S515	B08E515	B10S615	B10E615
Safety Approval	CE / UL <sup>(Note 4)</sup> / KCC <sup>(Note 4)</sup>						
Waterproof Degree	IP65 / NEMA4						
Operation Voltage <sup>(Note 5)</sup>	DC +24V (-10% ~ +15%) (please use isolated power supply)	DC +24V (-10% ~ +15%) (has built-in isolated power circuit <sup>(Note 3)</sup> )	DC +24V (-10% ~ +15%) (please use isolated power supply)	DC +24V (-10% ~ +15%) (please use isolated power supply)	DC +24V (-10% ~ +15%) (has built-in isolated power circuit <sup>(Note 3)</sup> )	DC +24V (-10% ~ +15%) (has built-in isolated power circuit <sup>(Note 3)</sup> )	
Voltage Endurance	AC500V for 1 minute (between charging (DC24V terminal) and FG terminals)						
Power Consumption <sup>(Note 5)</sup>	7.68W			5.2W	7.8W	12W	
Backup Battery	3V lithium battery CR2032 x 1						
Backup Battery Life	It depends on the temperature used and the conditions of usage, about 3 years or more at 25°C.						
Operation Temp.	0°C ~ 50°C						
Storage Temp.	-20°C ~ +60°C						
Ambient Humidity	10% ~ 90% RH [0 ~ 40°C], 10% ~ 55% RH [41 ~ 50°C] Pollution Degree 2						
Vibration Resistance	IEC 61131-2 Compliant 5Hz ≤ f < 9Hz = Continuous: 1.75mm / Occasional: 3.5mm 9Hz ≤ f ≤ 150Hz = Continuous: 0.5g / Occasional: 1.0g X, Y, Z directions for 10 times						
Dimensions (W) x (H) x (D) mm	184 x 144 x 50			227.1 x 174.1 x 61		272 x 200 x 61	
Panel Cutout (W) x (H) mm	172.4 x 132.4			219.4 X 166.5		261.3 X 189.3	
Weight	Approx. 800g			Approx. 1226g		Approx. 1520g	

## NOTE

- The half-life of backlight is defined as original luminance being reduced by 50% when the maximum driving current is supplied to HMI. The life of LED backlight shown here is an estimated value under 25°C normal temperature and humidity conditions.
- USB Host port can provide up to 5V/ 500mA of power.
- The withstand voltage of the isolated power circuit is 1500V peak for 1 minute.
- Some models are in the process of application to UL and KCC certification. For more information, please consult our distributors.
- The value of the power consumption indicates the electrical power consumed by HMI only without connecting to any peripheral devices. In order to ensure the normal operation, it is recommended to use a power supply which the capacity is 1.5 ~ 2 times the value of the power consumption.
- Users can download the DOPSoft software, the program editor of Delta HMI product and the user manual via the following link: <http://www.delta.com.tw/industrialautomation/>.
- The content of this quick start may be revised without prior notice. Please consult our distributors or download the most updated version at <http://www.delta.com.tw/industrialautomation/>.

DELTA'nın DOP-B serisi operatör panellerini seçtiğiniz için teşekkürler. Bu bilgi dökümanı Delta HMI kurulum, bağlantı, bakım ve kontrolünde kullanıcıya yardımcı olacaktır. Doğru kullanım için ürünü kullanmadan önce bu dökümanı mutlaka okuyunuz. Kurulum, bağlantı ve çalışma yapmadan önce güvenlik uyarılarını tamamen anladığınızdan emin olunuz. Bu dökümanı daha sonra da kullanmak için iyi muhafaza ediniz. Lütfen aşağıdaki güvenlik uyarılarına dikkat ediniz:

- Ürünün kurulumunu yanıcı gaz ve sıvılardan uzak kuru ve temiz ortamlara yapınız.
- Bağlantıları yaparken tüm bağlantı kurallarının sağlandığından emin olunuz.
- HMI'nın toprak bağlantısının doğru yapıldığından emin olunuz. Topraklama metodunun ürünü kuruluğu ülke standartlarına uygun olduğuna emin olunuz (NFPA 70: National Electrical Code, 2005 Ed.).
- HMI enerjili iken kablo bağlantısı yapmayınız ya da sökmeyiniz.
- Çalışma sırasında power supply terminallerine dokunmayınız. Aksi halde elektrik şoku olabilir.
- HMI yazılımının kurulumu, çalışması ve donanım bağlantısı ile ilgili daha fazla bilgi için lütfen HMI manualini inceleyiniz.

Ürünün kullanımı ile ilgili sorularınız için, lütfen teknik servisimizle bağlantıya geçiniz.

Herhangi bir ihbara gerek kalmaksızın bu bilgi dökümanının içeriği değiştirilebilir. Güncellenmiş versiyonu elde etmek için teknik servise danışabilir veya <http://www.delta.com.tw/industrialautomation> adresinden indirebilirsiniz.

## Güvenlik Uyarıları

Ürünü alırken, kontrol ederken, kurulumunu yaparken, çalıştırırken, bakım ve arıza teşhisi yaparken aşağıdaki güvenlik uyarılarına dikkat ediniz. DANGER, WARNING, ve STOP başlıkları DELTA HMI ürünü kullanırken yapılması gerekenleri dikkat çekmek için kullanılmıştır. Ürünün garantisini muhafaza etmek için bu uyarılara mutlaka dikkat ediniz!

### Kurulum



- Kurulumu bilgi dökümanında belirttiği gibi yapınız. Aksi halde ürün zarar görebilir.
- Ürünün kurulumunu bu dökümanda belirtilen özelliklerin dışındaki ortamlara yapmayınız. Aksi halde elektrik şoku, yangın ya da kişisel zararlara sebep olabilir.
- Ürünün kurulumunu bu dökümanda belirtilen sıcaklık değerlerinin dışındaki ortamlara yapmayınız. Aksi halde ürün zarar görebilir veya çalışmasında problem olabilir.
- Lütfen bu ürünün EMC standartlarına göre endüstriyel kullanım için olduğuna dikkat ediniz.
- Lütfen bu ürünü kişisel zarar, donanım hatası veya sistem acil durdurma gibi durumların önceden bildirmek amacıyla alarm cihazı olarak kullanmayınız.

### Bağlantı



- Toprak terminallerini class-3 topraklama yapınız. (Topraklama direnci 100Ω'u aşmamalıdır). Yanlış yapılan topraklama bağlantısı haberleşme hatasına, elektrik şokuna ve yangına sebep olabilir.

## Çalışma



- DELTA'nın HMI ürünlerini programlamak için Delta Screen Editor yazılımı kullanılmalıdır. DELTA HMI ürünlerini programlamak için Delta Screen Editor yazılımı dışında bir yazılım kullanılması durumunda HMI çalışmasında problem meydana gelebilir.
- Kişisel hataları ve ürün arızalarını önlemek için, HMI programını tasarlarken Delta HMI ile ona bağlı kontrol ünitesi veya donanım arasında haberleşme hatası olması durumunda sistem hatası veya arıza olmamasına dikkat ediniz.
- Hata, kapıp ve kaza ile silinmelere karşı lütfen HMI programının ve sayfa datalarının yedeğini alınız.



- Çalışma sırasında kablo bağlantılarını değiştirmeyiniz. Aksi halde elektrik şokuna veya kişisel zararlara sebep olabilir.
- Dokunmatik ekrana sert ve sivri nesnelere dokunarak basmayınız. Aksi halde HMI ekranı zarar görebilir, komutlara cevap veremeyebilir ve HMI'nın anormal çalışmasına sebep olabilir.

## Bakım ve Kontroller



- HMI içindeki devre elemanlarına dokunmayınız aksi halde elektrik şoku meydana gelebilir.
- Enerjiyi iken operatör paneli bağlantılarına müdahale etmeyiniz. Aksi halde elektrik şoku meydana gelebilir.
- HMI enerjisi kesildikten sonra HMI üzerinde tehlikeli seviyede elektrik şarj voltajı kalabileceğinden ürüne dokunmadan ve bağlantılara müdahale etmeden önce en az 10 dakika beklenilmesi tavsiye edilir.
- Pili değiştirmeden önce ürünün enerjisini kesin ve pili değiştirdikten sonra sistem ayarlarını kontrol ediniz. (Pil değiştirildikten sonra tüm datalar silinecektir).
- Çalışma sırasında havalandırma deliklerinin tıkalı olmadığından emin olunuz. Aksi halde kötü havalandırmadan veya aşırı sıcaklıktan dolayı ürün zarar görebilir.

## Bağlantı Metodu



- HMI'ya doküman da belirtilen değerlerin dışında voltaj bağlamayınız. Aksi halde elektrik şoku ve yangına sebep olabilir.
- Kablo bağlantısı yapmadan önce terminal bloğunu HMI'dan ayırınız.
- Terminal bloğundaki her bir terminale sadece tek bir kablo bağlayınız.
- Eğer bağlantıda hata varsa, bağlantıyı uygun aletleri kullanarak tekrar yapınız. Terminal ya da kabloları sökmek için güç uygulamayınız. Aksi halde ürün zarar görebilir.
- Enerji hattında bir kopukluk meydana gelmişse, bağlantıların sağlığını kontrol ettikten sonra tekrar enerji verin.

## Haberleşme Bağlantısı



- Haberleşme bağlantısını doküman da belirtildiği gibi yapınız.
- HMI kablo uzunlukları doküman da belirtildiği gibi olmalıdır.
- Haberleşme kalitesini artırmak için düzgün topraklama yapınız.
- Gürültü ve parazit önlemek için, haberleşme kablosu, tüm güç kabloları ve motor güç kabloları farklı kablo bloklarından geçirilmelidir.

## Kurulum ve Saklama Koşulları

Kurulum yapılan kadar ürün orjinal kutusu içinde muhafaza edilmelidir. Ürünün garanti kapsamının devamı için, ürün belli bir süre kullanılmıyacaksa, HMI uygun bir şekilde saklanmalıdır. Bazı saklama önerileri:

- Doğrudan güneş ışığının temas etmediği kuru ve temiz ortamda saklanmalıdır.
- -20°C - +60°C (-4°F - 140°F) sıcaklık aralığında saklanmalıdır.
- 10% - 90% rutubet aralığında ve yoğunlaşmasız ortamda saklanmalıdır.
- HMI aşındırıcı sıvı ve gaz bulunan ortamlarda saklanmamalıdır.
- Ürün uygun paketlenmeli, sert ve düz bir yüzeyde saklanmalıdır.
- HMI doğrudan güneş ışığının temas ettiği yerlere ya da ısı yayan nesnelere yakınına monte edilmemelidir.



- HMI aşındırıcı gaz ve sıvının olduğu toz veya metal parçacıkların bulunduğu yerlere monte edilmemelidir.
- HMI dokümanda belirtilen sıcaklık ve rutubet oranları dışında ortamlara monte edilmemelidir.
- HMI dokümanda belirtilen titreşim ve şok oranlarının üzerindeki ortamlara monte edilmemelidir.
- HMI yüksek seviyede elektromanyetik radyasyonun bulunduğu ortamlara monte edilmemelidir.

## Kurulum

### Kurulum Notları

- Yanlış kurulum yapılması ürünün zarar görmesini veya çalışma ömrünün kısalmasına sebep olur. HMI kurulumunun doküman da belirtildiği gibi yapılması gerekir.
- HMI'nın havalandırmasının doğru olduğuna emin olmak için, havalandırma deliklerinin tıkalı olmadığına ve HMI etrafına gerekli boşluğun bırakıldığına emin olunuz.
- Panelin korumasını sağlama almak için, HMI içine su geçirmez conta takınız.
- Düz yüzey, Tip 4X "Sadece kapalı alanda kullanım" ve eşdeğer ortamlarda kurulum yapılmalıdır.
- Montaj için kullanılan panelin kalınlığı 5 mm'den az olmalıdır.

### Kurulum Metodu:

#### Adım 1:

HMI içine su geçirmez contanın takıldığına emin olunuz ve sonra pano boşluğuna yerleştiriniz.

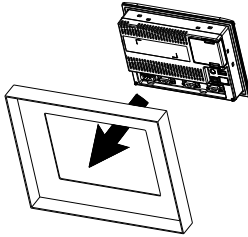

#### Adım 2:

Montaj aparatlarını HMI'nın yuvalarına yerleştiriniz ve sonra panoya değene kadar vidaları sıkınız.

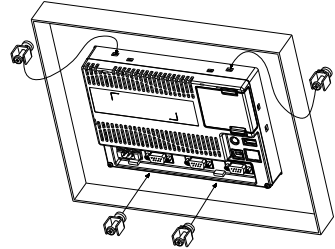

#### Adım 3:

Plastik kasaya zarar vermemek için vidayı 0.7N.M'den az bir tork ile sıkınız.

Tork: 6.17lb-inch(0.7N-M)

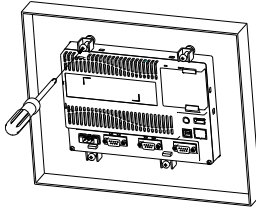

#### Adım 4:

Isı dağılımı sağlanabilmesi için HMI arka paneli ile duvar, kurulum yüzeyi veya başka kontrol cihazı arasında en az 60 mm boşluk bırakınız.

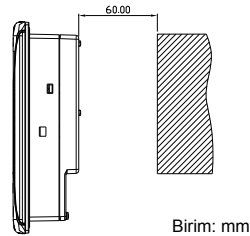

## Montaj aparatı ölçüleri.

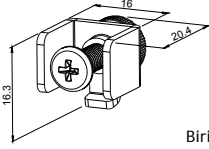

Birim: mm

## Bağlantı

Bağlantı yaparken aşağıdaki bağlantı noktalarına dikkat ediniz.

### Bağlantı Notları

- Elektrik şokunu önlemek için, enerji varken bağlantı yapmayınız.
- HMI'nın power anahtarı olmadığı için, besleme kablosuna şalter konulduğuna emin olunuz.
- Bağlantı için lütfen çift dolanmış sarmal (twisted pair) kablo kullanınız.

Tavsiye edilen bağlantı şekli aşağıdadır:

Tip	Kablo Kesiti (AWG)	Soyulacak uzunluk	Tork
Solid	28 ~ 12	7 ~ 8 mm	5 kg-cm (4.3 lb-in)
Stranded	30 ~ 12	7 ~ 8 mm	5 kg-cm (4.3 lb-in)

Lütfen bağlantının aşağıdaki şekilde gösterildiği gibi olduğuna emin olunuz. (power supply konektör).

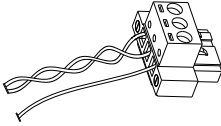

## Temel Kontrol

Madde	Açıklama
Genel Kontrol	<ul style="list-style-type: none"><li>■ HMI bağlantılarını periyodik olarak kontrol ediniz. Titreşim ve sıcaklık değişiminden dolayı gevşeyen vidaları sıkınız.</li><li>■ HMI içine, kontrol paneline veya havalandırma slot ve deliklerine yağ, su, metal parçalar veya yabancı nesnelerin düşmediğine emin olunuz. Bu durum ürüne zarar verir.</li><li>■ Kurulumu doğru yaptığınıza emin olunuz. Ortamda toz, zararlı gaz ve sıvılar olmamalıdır.</li></ul>
Çalışmadan önce kontrol (enerji verilmeden önce)	<ul style="list-style-type: none"><li>■ Tüm bağlantı terminallerinin doğru izole olduğundan emin olunuz.</li><li>■ Zarar ve hasar meydana gelmemesi için tüm bağlantıların doğru yapıldığına emin olunuz.</li><li>■ HMI içinde kullanılmayan vidaların, metal parçaların, iletken veya yanıcı maddelerin olmadığını gözle kontrol ediniz.</li><li>■ Ürünü etkileyebilecek elektromanyetik gürültünün düşük olduğuna emin olunuz.</li><li>■ HMI ünitesine uygulanan harici voltajın doğru ve ürüne uygun olduğunu kontrol ediniz.</li></ul>
Çalıştırmadan önce kontrol (enerji verildikten sonra)	<ul style="list-style-type: none"><li>■ Power LED ışığının yandığını kontrol ediniz.</li><li>■ Cihazlar arasında haberleşmenin normal olduğunu kontrol ediniz.</li><li>■ Anormal bir durum ile karşılaştığınızda teknik servisimize bağlantınıza geçiniz.</li></ul>

## Seri Haberleşme Pin Açıklaması

DOP-B07S(E)415 / DOP-B07PS415 / DOP-B08S(E)515 / DOP-B10S(E)615 Serisi

### COM1 Port (Flow Control destekler)

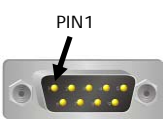
COM Port	PIN	Bağlantı
		RS-232
	1	
	2	RXD
	3	TXD
	4	
	5	GND
	6	
	7	RTS
	8	CTS
	9	

Not: Boş pin = Bağlantı yok.

### COM2 Port (Flow Control destekler)

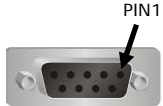
COM Port	PIN	MOD 1	MOD 2	MOD 3
		RS-232	RS-422	RS-485
	1		TXD+	D+
	2	RXD		
	3	TXD		
	4		RXD+	
	5	GND	GND	GND
	6		TXD-	D-
	7	RTS		
	8	CTS		
	9		RXD-	

Not 1: Boş pin = Bağlantı yapılmaz.

Not 2: COM2 portu RS-232 flow control kullanılacağı zaman, RTS ve CTS sinyalleri flow control olarak kullanılır, COM3 portu kullanılamaz.

Not 3: COM2 portu RS-422 flow control kullanılacağı zaman, lütfen aşağıdaki COM3 port pin sinyal çıkışlarını inceleyiniz. Parantez içinde gösterilen RTS+, CTS+, RTS- ve CTS- sinyalleri flow control olarak kullanılır.

### COM3 Port

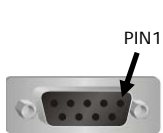
COM Port	PIN	MOD 1	MOD 2	MOD 3
		RS-232	RS-422	RS-485
	1		TXD+(RTS+)	D+
	2	RXD		
	3	TXD		
	4		RXD+(CTS+)	
	5	GND	GND	GND
	6		TXD-(RTS-)	D-
	7			
	8			
	9		RXD-(CTS-)	

Not 1: Boş pin = Bağlantı yapılmaz.

Not 2: COM2 portu RS-422 flow control kullanılacağı zaman, lütfen yukarıdaki COM3 port pin sinyal çıkışlarını inceleyiniz. Parantez içinde gösterilen RTS+, CTS+, RTS- ve CTS- sinyalleri flow control olarak kullanılır.

## Ethernet Arabirim (LAN)

Ethernet Arabirim (LAN)	PIN	Bağlantı
		Ethernet
	1	TX+
	2	TX-
	3	RX+
	4	
	5	
	6	RX-
	7	
	8	

Not: Boş pin = Bağlantı yapılmaz.

## DOP-B05 / DOP-B07S(E)515 / DOP-B07PS515 Serisi

### COM1 Port (Flow Control destekler)

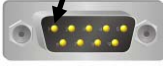
COM Port	PIN	Bağlantı
		RS-232
	1	
	2	RXD
	3	TXD
	4	
	5	GND
	6	
	7	RTS
	8	CTS
	9	

Not: Boş pin = Bağlantı yapılmaz.

### COM2 ve COM3 Port

COM Port	PIN	MOD 1		MOD 2		MOD 3	
		COM2 RS-232	COM3 RS-485	COM2 RS-485	COM3 RS-485	COM2 RS-232	COM3 RS-422
	1			D+			TXD+
	2	RXD				RXD	
	3	TXD				TXD	
	4		D+		D+		RXD+
	5		GND		GND		GND
	6			D-			TXD-
	7						
	8						
	9			D-		D-	

Not 1: Boş pin = Bağlantı yapılmaz.

Not2: B05 / B07S(E)515 / B07PS515 serisi modeller RS-422 flow control desteklemezler.

## Parça İsimleri

### DOP-B05S100 / DOP-B05S101 (Ön Görünüm)

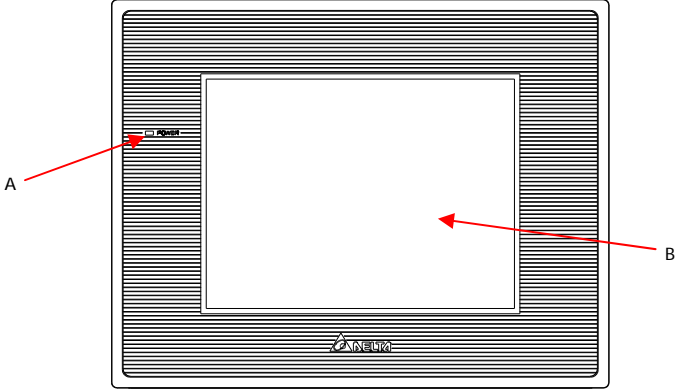

- |   |   |
|---|---|
| A | Power LED Indikator (HMI normal çalıştığı zaman yeşil yanar.) |
| B | Touch Screen / Display  |

### DOP-B05S100 / DOP-B05S101 (Arka Görünüm)

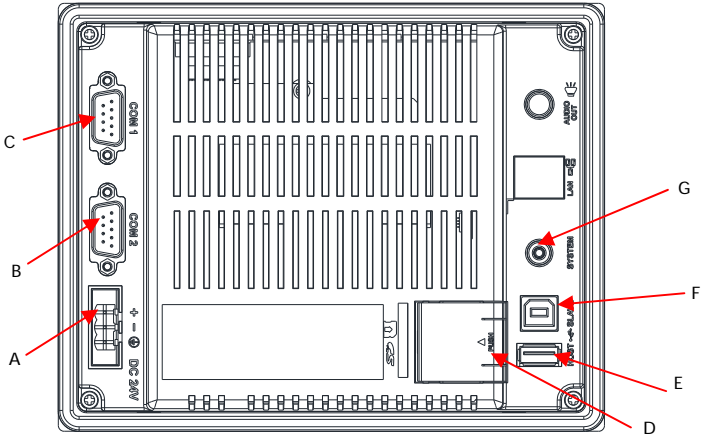

- |   |  |   |             |
|---|--|---|-------------|
| A | Power Giriş Terminali                                  | E | USB Host    |
| B | COM2 (COM3 olarak genişletilebilir <sup>(Not1)</sup> ) | F | USB Client  |
| C | COM1   | G | Sistem Tuşu |
| D | Pil Kapağı   | - | -           |

#### NOTE

1. Ayar yapmak için, lütfen seri haberleşme pin açıklamasına bakınız.

## DOP-B07S(E)515 / DOP-B07PS515 (Ön Görünüm)

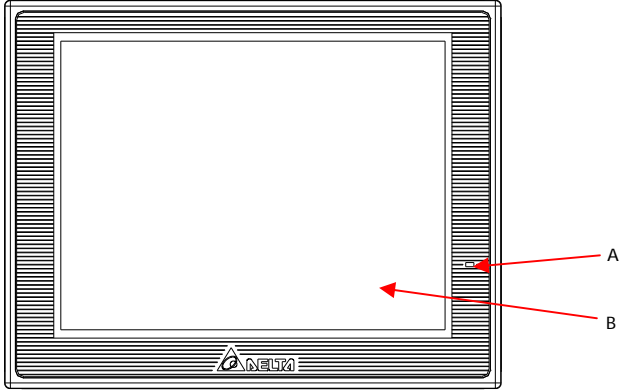

- |   |   |
|---|---|
| A | Power LED Indikator (HMI normal çalıştığı zaman yeşil yanar.) |
| B | Touch Screen / Display  |

## DOP-B07S(E)515 / DOP-B07PS515 (Arka Görünüm)

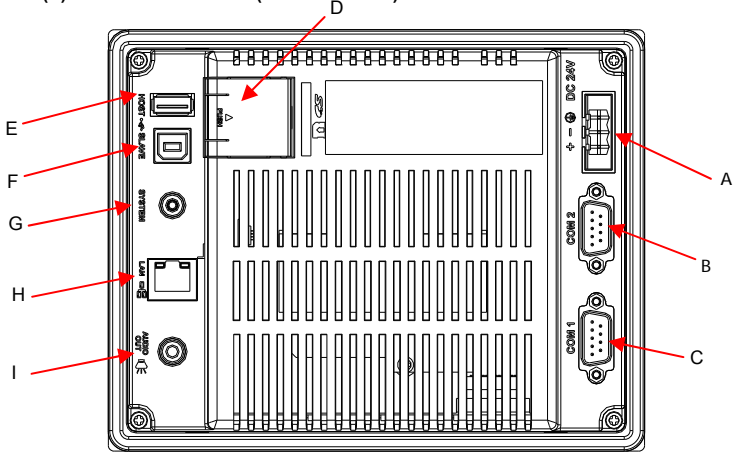





A	Power Giriş Terminali	F	USB Client
B	COM2 (COM3 olarak genişletilebilir <sup>(Not1)</sup> )	G	Sistem Tuşu
C	COM1	H	Ethernet Arabirim (LAN)
D	Memory Card Slot / Pil Kapağı	I	Audio Çıkış Arabirimi
E	USB Host	-	-

### **NOTE**

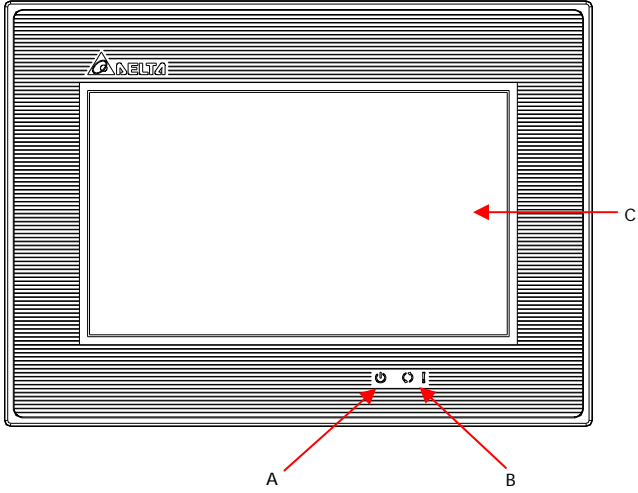
1. Ayar yapmak için, lütfen seri haberleşme pin açıklamasına bakınız.

DOP-B07S(E)415 / DOP-B07PS415 (Ön Görünüm)



A	 : Power LED Indikator HMI normal çalıştığıında yeşil yanar.
C	 : Çalışma LED Indikator (Mavi) <sup>(Not 1)</sup> Haberleşme sağlandığı zaman veya data iletişimi sırasında çalışma LED'i mavi flash yapar . (Lütfen aşağıdaki Not 1'i inceleyiniz).  : Alarm LED Indikator (Kırmızı) Herhangi bir alarm aktif olduğunda Alarm LED indikator kırmızı flash yapar.
D	Touch Screen / Display

 **NOTE**

1. Çalışma LED indikatörü (mavi) tanımlaması kullanıcı tarafından belirlenebilir.

## DOP-B07S(E)415 / DOP-B07PS415 (Arka Görünüm)

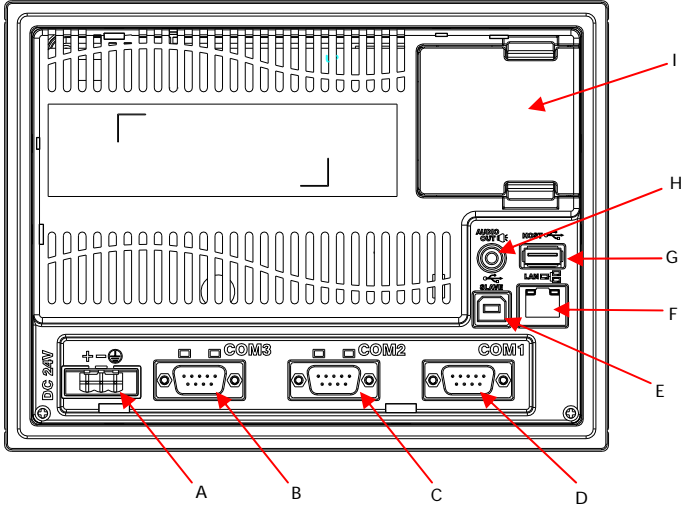





A	Power Giriş Terminal
B	COM3 (Haberleşme sırasında HMI'nın yazma ve okuma durumunu gösteren iki LED indikator sağlar.)
C	COM2 (Haberleşme sırasında HMI'nın yazma ve okuma durumunu gösteren iki LED indikator sağlar.)
D	COM1
E	USB Client
F	Ethernet Arabirim (LAN)
G	USB Host
H	Audio Çıkış Arabirimi
I	Memory Card Slot / Pili Kapağı

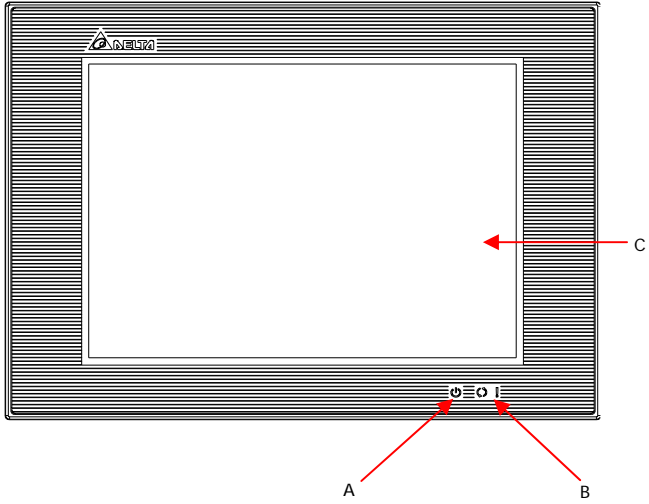

## DOP-B08S(E)515 (Ön Görünüm)



A	 : Power LED Indikator HMI normal çalıştığıında yeşil yanar.
B	 : Çalışma LED Indikator (Mavi) <sup>(Not1)</sup> Haberleşme sağlandığı zaman veya data iletişimi sırasında çalışma LED'i mavi flash yapar . (Lütfen aşağıdaki Not 1'i inceleyiniz).  : Alarm LED Indikator (Kırmızı) Herhangi bir alarm aktif olduğunda Alarm LED indikator kırmızı flash yapar.
C	Touch Screen / Display

 **NOTE**

1. Çalışma LED indikatörü (mavi) tanımlaması kullanıcı tarafından belirlenebilir.



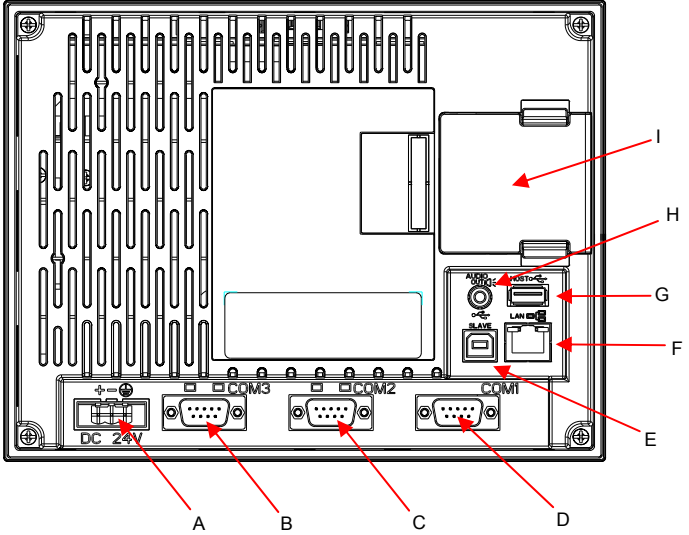

## DOP-B08S(E)515 (Arka Görünüm)

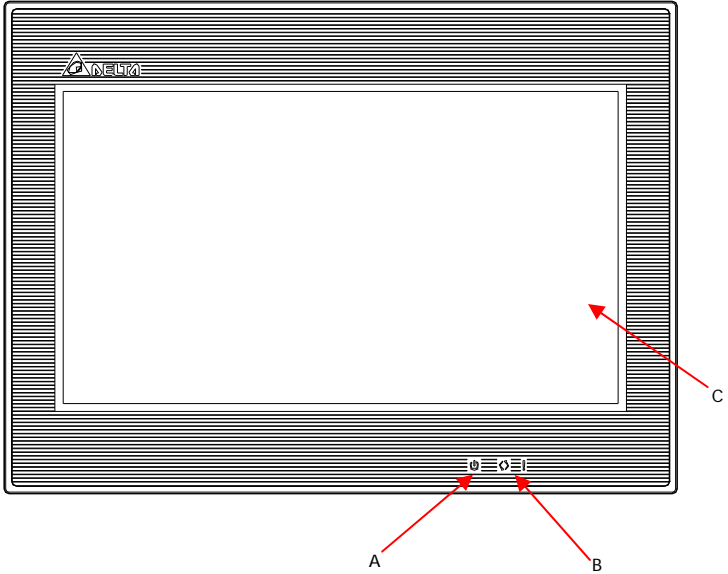

A	Power Giriş Terminal
B	COM3 (Haberleşme sırasında HMI'nın yazma ve okuma durumunu gösteren iki LED indiktor sağlar.)
C	COM2 (Haberleşme sırasında HMI'nın yazma ve okuma durumunu gösteren iki LED indiktor sağlar.)
D	COM1
E	USB Client
F	Ethernet Arabirim (LAN)
G	USB Host
H	Audio Çıkış Arabirimi
I	Memory Card Slot / Pili Kapağı

## DOP-B10S(E)615 (Ön Görünüm)



A	 : Power LED Indikator HMI normal çalıştığıında yeşil yanar.
B	 : Çalışma LED Indikator (Mavi) <sup>(Not1)</sup> Haberleşme sağlandığı zaman veya data iletişimi sırasında çalışma LED'i mavi flash yapar . (Lütfen aşağıdaki Not 1'i inceleyiniz).  : Alarm LED Indikator (Kırmızı) Herhangi bir alarm aktif olduğunda Alarm LED indikator kırmızı flash yapar.
C	Touch Screen / Display
	<b>NOTE</b> 1. Çalışma LED indikatörü (mavi) tanımlaması kullanıcı tarafından belirlenebilir.

## DOP-B10S(E)615 (Arka Görünüm)

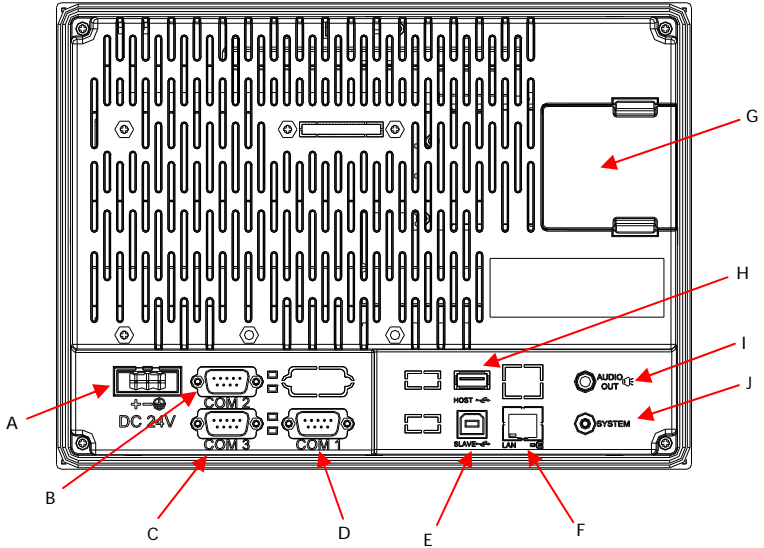

A	Power Giriş Terminal
B	COM2 (Haberleşme sırasında HMI'nın yazma ve okuma durumunu gösteren iki LED indiktor sağlar.)
C	COM3 (Haberleşme sırasında HMI'nın yazma ve okuma durumunu gösteren iki LED indiktor sağlar.)
D	COM1
E	USB Client
F	Ethernet Arabirim (LAN)
G	Memory Card Slot / Pili Kapağı
H	USB Host
I	Audio Çıkış Arabirimi
J	Sistem Tuşu

## Panel Kesim Ölçüleri

DOP-B05S100 / DOP-B05S101

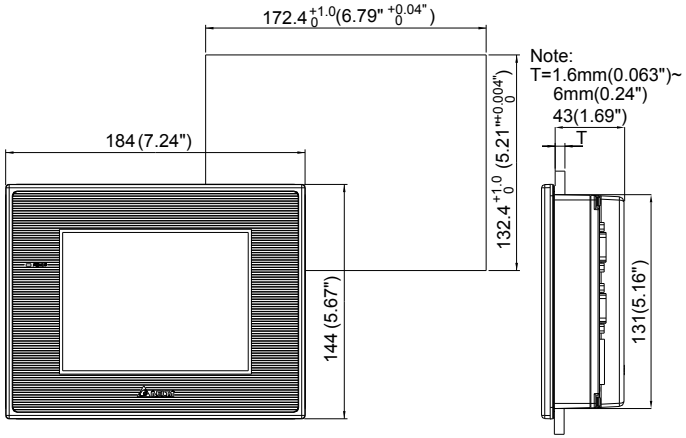

Birim: mm (inch)

DOP-B07S(E)415 / DOP-B07PS415

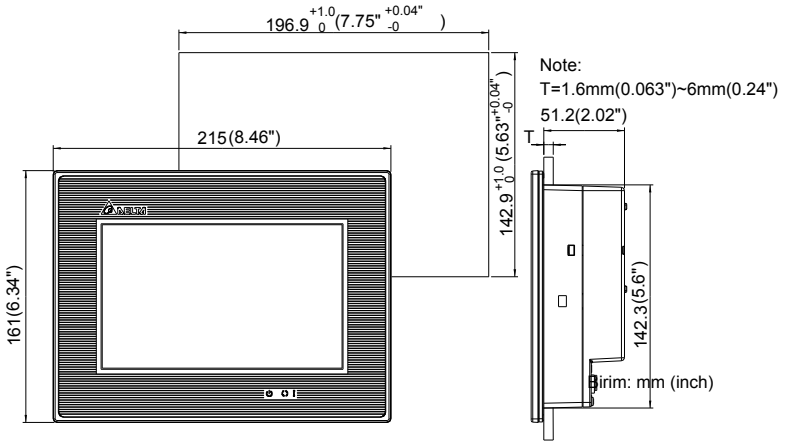

Birim: mm (inch)

Birim: mm (inch)

DOP-B07S(E)515 / DOP-B07PS515

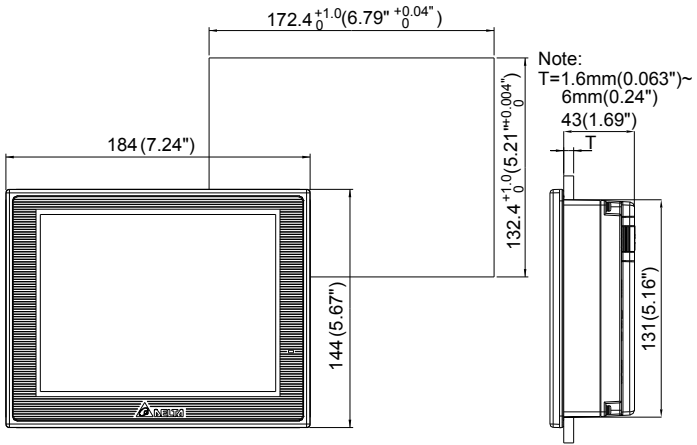

Birim: mm (inch)

DOP-B08S(E)515

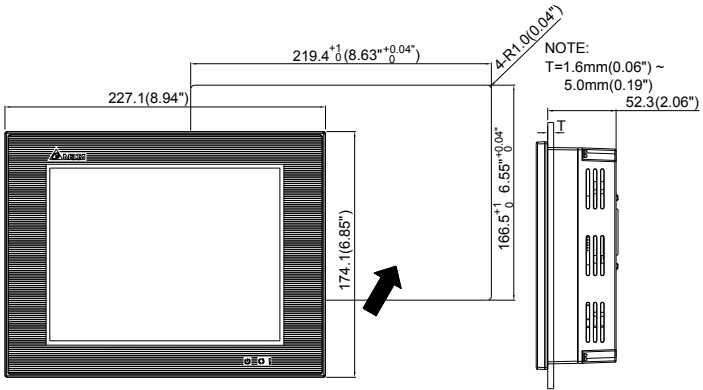

Birim: mm (inch)

DOP-B10S(E)615

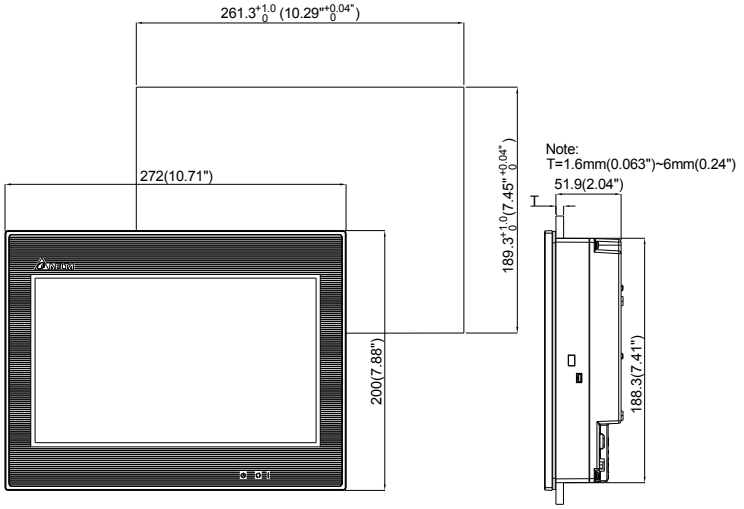

Birim: mm (inch)

## Özellikler

MODEL		B05S100	B05S101	B07S415	B07E415	B07PS415
LCD MODÜL	Display Tipi	5.6" TFT LCD (65536 renk)		7" Geniş Ekran TFT LCD (65536 renk)		
	Çözünürlük	320 x 234 piksel		800 x 480 piksel		
	Arka Işık	LED Aydınlatma (25°C yarım ömürde 20,000 saatten az) <sup>(Not 1)</sup>				
	Display Ölçüsü	113.28 x 84.70mm		152.4 x 91.44mm		
Operation System		Delta Real Time OS				
MCU		32-bit RISC Micro-controller				
NOR Flash ROM		Flash ROM 4 MB (OS Sistem: 2MB / Uygulama: 2MB)	Flash ROM 8 MB (OS Sistem: 2MB / Uygulama: 6MB)	Flash ROM 128 MB (OS Sistem: 30MB / Backup: 16MB / Uygulama: 82MB)		
SDRAM		8Mbytes	16Mbytes	64Mbytes		
Backup Memory		128Kbytes		16Mbytes		
Ses Efekt Çıkışı	Buzzer	Multi-Tone Frekans (2K ~ 4K Hz) / 85dB				
	AUX	N/A	N/A	N/A	Steryo çıkış	N/A
Ethernet Arabirim		N/A	N/A	N/A	IEEE 802.3, IEEE 802.3u 10/100 Mbps oto-algılama (dahili izoleli güç devresi) <sup>(Not 3)</sup>	N/A
Memory Card		N/A	N/A	SD Card (SDHC destekler)		
USB		1 USB Host <sup>(Note 2)</sup> Ver 1.1 / 1 USB Slave Ver 1.1		1 USB Host <sup>(Note 2)</sup> Ver 2.0 / 1 USB Slave Ver 1.1		
Seri COM Port	COM1	RS-232 (hardware flow control destekler)				
	COM2	RS-232 / RS-485	RS-232 / RS-422 / RS-485	RS-232 / RS-422 / RS-485 (dahili izoleli güç devresi) <sup>(Not 3)</sup>	RS-232 / RS-422 / RS-485	
	COM3	RS-422 / RS-485	RS-232 / RS-422 / RS-485	RS-232 / RS-422 / RS-485 (dahili izoleli güç devresi) <sup>(Not 3)</sup>	RS-232 / RS-422 / RS-485	
Fonksiyon Tuşu		N/A				
Gerçek Zaman Saati (RTC)		Dahili				
Soğutma Metodu		Doğal Hava Soğutma				
Güvenlik Onayı		CE / UL <sup>(Note 4)</sup> / KCC <sup>(Note 4)</sup>				



MODEL	B05S100	B05S101	B07S415	B07E415	B07PS415
Su geçirmezlik derecesi	IP65 / NEMA4				
Çalışma Voltajı (Not 5)	DC +24V (-10% ~ +15%) (lütfen izoleli güç kaynağı kullanınız)		DC +24V (-10% ~ +15%) (lütfen izoleli güç kaynağı kullanınız)	DC +24V (-10% ~ +15%) (dahili izoleli güç devresi (Not 3))	DC +24V (-10% ~ +15%) (lütfen izoleli güç kaynağı kullanınız)
Dayanma Voltajı	1 dakika için AC500V (besleme (DC24V terminal) ve FG terminalleri arası)				
Güç Tüketimi (Not 5)	3.0W		5W	7.5W	5W
Backup Battery	3V lityum pil CR2032 x 1				
Backup Battery Ömrü	Kullanım koşullarına ve ortam sıcaklığına bağlı, 25°C'de 3 yıl veya daha fazla.				
Çalışma Sıcaklığı	0°C ~ 50°C				
Saklama Sıcaklığı	-20°C ~ +60°C				
Rutubet Oranı	10% ~ 90% RH [0 ~ 40°C], 10% ~ 55% RH [41 ~ 50°C] Kirlenme Derecesi 2				
Titreşim Direnci	IEC 61131-2 Uyumlu 5Hz ≤ f < 9Hz = Sürekli: 1.75mm / Geçiçi: 3.5mm 9Hz ≤ f ≤ 150Hz = Sürekli: 0.5g / Geçiçi: 1.0g X, Y, Z yönünde 10 defa				
Ölçüler (W) x (H) x (D) mm	184 x 144 x 50		215 x 161 x 50		
Panel Kesim (W) x (H) mm	172.4 x 132.4		196.9 x 142.9		
Ağırlık	Yaklaşık 670g		Yaklaşık 970g		

## NOTE

- Arka ışık yarım-ömrü, HMI maksimum akımla beslendiğinde orijinal aydınlatmanın %50 düşürüldüğü anlamına gelir. Yukarıda gösterilen arka ışık LED aydınlatma ömrü 25 derecede normal sıcaklık ve rutubet ortamında tahmin edilen değerlerdir.
- USB Host port 5V/ 500mA güç sağlar.
- İzoleli güç devresinin 1 dakika için peak değeri 1500V.
- Bazı modeller için UL ve KCC başvurusu yapılmış ve işlem aşamasındadır. Daha fazla bilgi için teknik servisimizle bağlantıya geçebilirsiniz.
- Güç tüketimi değeri sadece HMI için olup hiç bir harici cihaza bağlı değilken ki değerdir. Normal çalışmayı garanti altına almak için özelliklerde belirtilen güç değerinin 1.5 veya 2 katı güç tüketimini karşılayacak bir güç kaynağı ile kullanılması önerilir.
- DELTA HMI ürününü DOPSoft yazılımını ve kullanıcı manualini aşağıdaki linkten indirebilirsiniz:  
<http://www.delta.com.tw/industrialautomation/>.
- Herhangi bir ihbar olmadan bu dökümanın içeriği değiştirilebilir. En son güncellenmiş halini firmamızdan talep edebilir yada aşağıdaki link adresinden indirebilirsiniz  
<http://www.delta.com.tw/industrialautomation/>.

MODEL		B07S515	B07E515	B07PS515	B08S515	B08E515	B10S615	B10E615
LCD MODÜL	Display Tipi	7" TFT LCD (65536 renk)			8" TFT LCD (65536 renk)		10.1" Geniş Ekran TFT LCD (65536 renk)	
	Çözünürlük	800 x 600 piksel			800 x 600 piksel		1024 x 600 piksel	
	Arka ışık	LED Aydınlatma (25°C yarım ömürde 10,000 saatten az) <sup>(Not 1)</sup>						
	Display Ölçü	141 x 105.75mm			162 x 121.5mm		226 x 128.7mm	
İşletim Sistemi		Delta Real Time OS						
MCU		32-bit RISC Micro-controller						
NOR Flash ROM		Flash ROM 128 MB(OS Sistem: 30MB / Backup: 16MB / Uygulama: 82MB)			Flash ROM 128 MB(OS Sistem: 30MB / Backup: 16MB / Uygulama: 82MB)		Flash ROM 128 MB(OS Sistem: 30MB / Backup: 16MB / Uygulama: 82MB)	
SDRAM		64Mbytes						
Backup Memory		16Mbytes						
Ses Efekt Çıkışı	Buzzer	Multi-Tone Frekans (2K ~ 4K Hz) / 85dB						
	AUX	N/A	Stereo çıkış	N/A	N/A	Stereo çıkış	N/A	Stereo çıkış
Ethernet Arabirim		N/A	IEEE 802.3, IEEE 802.3u 10/100 Mbps oto-algilama (dahili izole güç devresi <sup>(Not 3)</sup> )	N/A	N/A	IEEE 802.3, IEEE 802.3u 10/100 Mbps oto-algilama (dahili izole güç devresi <sup>(Not 3)</sup> )	N/A	IEEE 802.3, IEEE 802.3u 10/100 Mbps oto-algilama (dahili izole güç devresi <sup>(Not 3)</sup> )
Memory Card		SD Card (SDHC destekler)						
USB		1 USB Host <sup>(Note 2)</sup> Ver 2.0 / 1 USB Slave Ver 1.1						
Serial COM Port	COM1	RS-232 (hardware flow control destekler)						
	COM2	RS-232 / RS-485	RS-232 / RS-485 (dahili izole güç devresi <sup>(Not 3)</sup> )	RS-232 / RS-485	RS-232 / RS-422 / RS-485	RS-232 / RS-422 / RS-485 (dahili izole güç devresi <sup>(Not 3)</sup> )	RS-232 / RS-422 / RS-485	RS-232 / RS-422 / RS-485 (dahili izole güç devresi <sup>(Not 3)</sup> )
	COM3	RS-422 / RS-485	RS-422 / RS-485 (dahili izole güç devresi <sup>(Not 3)</sup> )	RS-422 / RS-485	RS-232 / RS-422 / RS-485	RS-232 / RS-422 / RS-485 (dahili izole güç devresi <sup>(Not 3)</sup> )	RS-232 / RS-422 / RS-485	RS-232 / RS-422 / RS-485 (dahili izole güç devresi <sup>(Not 3)</sup> )
Fonksiyon Tuşları		N/A						
Gerçek Zaman Saati (RTC)		Dahili						
Soğutma Metodu		Doğal Hava Soğutma						
Güvenlik Onayı		CE / UL <sup>(Note 4)</sup> / KCC <sup>(Note 4)</sup>						
Su geçirmezlik derecesi		IP65 / NEMA4						

MODEL	B07S515	B07E515	B07PS515	B08S515	B08E515	B10S615	B10E615
Çalışma voltajı (Not 5)	DC +24V (-10% ~ +15%) (Lütfen izoleli güç kaynağı kullanınız)	DC +24V (-10% ~ +15%) (dahili izole güç devresi (Not 3))	DC +24V (-10% ~ +15%) (Lütfen izoleli güç kaynağı kullanınız)	DC +24V (-10% ~ +15%) (Lütfen izoleli güç kaynağı kullanınız)	DC +24V (-10% ~ +15%) (dahili izole güç devresi (Not 3))	DC +24V (-10% ~ +15%) (dahili izole güç devresi (Not 3))	
Dayanma Voltajı	1 dakika için AC500V (DC24V terminal ve FG terminalleri arasında)						
Güç Tüketimi (Not 5)	7.68W		5.2W		7.8W		12W
Backup Battery	1 adet 3V lityum pil CR2032						
Backup Battery Ömrü	Kullanım koşullarına ve ortam sıcaklığına bağlı, 25°C'de 3 yıl veya daha fazla.						
Çalışma Sıcaklığı	0°C ~ 50°C						
Saklama Sıcaklığı	-20°C ~ +60°C						
Rutubet Oranı	10% ~ 90% RH [0 ~ 40°C], 10% ~ 55% RH [41 ~ 50°C] Kirlenme Derecesi 2						
Titreşim Direnci	IEC 61131-2 Uyumlu 5Hz ≤ f < 9Hz = Sürekli: 1.75mm / Geçici: 3.5mm 9Hz ≤ f ≤ 150Hz = Sürekli: 0.5g / Geçici: 1.0g X, Y, Z yönünde 10 defa						
Ölçüler (W) x (H) x (D) mm	184 x 144 x 50		227.1 x 174.1 x 61		272 x 200 x 61		
Panel Kesim (W) x (H) mm	172.4 x 132.4		219.4 X 166.5		261.3 X 189.3		
Ağırlık	Yaklaşık 800g		Yaklaşık 1226g		Yaklaşık 1520g		

## NOTE

- Arka ışık yarı-ömrü, HMI maksimum akımla beslendiğinde orijinal aydınlatmanın %50 düşürüldüğü anlamına gelir. Yukarıda gösterilen arka ışık LED aydınlatma ömrü 25 derecede normal sıcaklık ve rutubet ortamında tahmin edilen değerlerdir.
- USB Host port 5V/ 500mA güç sağlar.
- İzoleli güç devresinin 1 dakika için peak değeri 1500V.
- Bazı modeller için UL ve KCC başvurusu yapılmış ve işlem aşamasındadır. Daha fazla bilgi için teknik servisimize bağlantıya geçebilirsiniz.
- Güç tüketimi değeri sadece HMI için olup hiç bir harici cihaza bağlı değilken ki değerdir. Normal çalışmayı garanti altına almak için özelliklerde belirtilen güç değerinin 1.5 veya 2 katı güç tüketimini karşılayacak bir güç kaynağı ile kullanılması önerilir.
- DELTA HMI ürününü DOPSoft yazılımını ve kullanıcı manualini aşağıdaki linkten indirebilirsiniz:  
<http://www.delta.com.tw/industrialautomation/>.
- Herhangi bir ihbar olmadan bu dökümanın içeriği değiştirilebilir. En son güncellenmiş halini firmamızdan talep edebilir yada aşağıdaki link adresinden indirebilirsiniz  
<http://www.delta.com.tw/industrialautomation/>.

感謝您使用本產品。本人機介面安裝手冊提供 DOP-B 系列人機介面的相關資訊。在使用之前，請您仔細詳讀本手冊以確保使用上的正確。此外，請妥善將其放置在明顯的地點以便隨時查閱。下列事項在您尚未讀完本手冊前，請務必遵守：

- 安裝的環境必須沒有水氣、腐蝕性氣體及可燃性氣體。
- 接線時，請依接線圖說明施工。
- 接地工程必須確實實施，接地時須遵照國家現行相關電工法規之規定施行（請參考 NFPA 70: National Electrical Code, 2005 Ed.）。
- 在通電時，請勿拆解人機介面或更改配線。
- 在通電運作時，請勿接觸電源處，以免觸電。

如果您在使用上仍有問題，請洽詢經銷商或者本公司客服中心。由於產品精益求精，當內容規格有所修正時，請洽詢代理商或至台達網站 (<http://www.delta.com.tw/industrialautomation/>) 下載最新版本。

## 安全注意事項

安裝、配線、操作、維護及檢查時，應隨時注意以下安全注意事項。

### 安裝注意

- 
- 依照手冊指定的方式安裝人機介面，否則可能導致設備損壞。
  - 禁止將本產品暴露在有水氣、腐蝕性氣體、可燃性氣體等物質的場所下使用，否則可能會造成觸電、火災或爆炸。
  - 請勿將人機介面安裝在超過規格範圍的溫度環境中，否則可能造成人機介面無法正常運作或損壞。
  - 本產品為 KCC Class A（商用設備）產品且通過試驗認證，其設計的目的是在商業或是工業環境使用，而非家庭環境中使用。若在此情況下不小心購買或售出的人機介面產品，請將其更換為有符合 KCC Class B（家用設備）認證之產品。
  - 請勿將人機介面用於可能會造成人員傷亡、設備損壞或系統停機等警報機台。

### 配線注意

- 
- 請將接地端子連接到 class-3（100 Ω以下）接地，接地不良可能會造成通訊異常、觸電或火災。

## 操作注意



- 人機介面需配合編輯軟體規劃畫面，未經規劃或確認之人機介面可能會導致不正常運轉結果。為避免操作人身傷害或設備損壞，規劃人機畫面時，要確保人機介面及其連接控制器或設備之間的通訊故障不會造成設備功能無法正常運作。
- 為避免預防意外遺失程式，請務必備份規劃好的人機介面畫面程式。



- 不得在開啟電源情況下改變配線，否則可能造成觸電或人員受傷。
- 請勿以尖銳物品碰觸面板，否則可能導致面板凹陷，進而使人機介面無法正常運作。

## 保養及檢查



- 禁止接觸人機介面內部，否則可能會造成觸電。
- 電源啟動時，禁止拆下人機介面面板，否則可能會造成觸電。
- 電源關閉 10 分鐘內，不得接觸接線端子，殘餘電壓可能造成觸電。
- 更換備用電池時，應切斷電源再進行，並在更換後重新檢查系統設定值。
- 人機介面在操作時，排氣孔不可封住，否則人機容易因為散熱不良而造成故障。

## 配線方法



- 請勿使用超過人機介面規格範圍的電壓，否則可能會引起觸電或火災。
- 配線時請將快速接頭從人機介面的本體上拆下來。
- 快速接頭的一個電線插入口，請僅插入一根電線。
- 對於錯誤強行拔出電線的動作，請重新檢查連接電線再啟動。

## 通訊電路的配線



- 請依標準規格採用通訊配線線材。
- 通訊線材長度需在符合規定內。
- 採用正確的接地迴路，以避免通訊不良。
- 為防止較大的雜訊干擾引起，人機介面無法正常運作，請用單獨的配線槽將人機介面的通訊電纜和所有電源線及馬達動力線分開。

## 安裝環境條件

本產品在安裝之前必須置於其包裝箱內，若暫時不使用，為了使該產品能夠符合本公司的保固範圍及日後的維護，儲存時務必注意下列事項：

- 必須置於無塵垢、乾燥之位置。
- 儲存位置的環境溫度必須在  $-20^{\circ}\text{C}$  to  $+60^{\circ}\text{C}$  (  $-4^{\circ}\text{F}$  to  $140^{\circ}\text{F}$  ) 範圍內。
- 儲存位置的相對溼度必須在 10% 到 90% 範圍內，且無結露。

- 避免儲存於含有腐蝕性氣、液體之環境中。
- 最好適當包裝存放在架子或檯面。
- 本產品適合的安裝環境包括有：無發高熱裝置之場所；無水滴、蒸氣、灰塵及油性灰塵之場所；無腐蝕、易燃性之氣、液體之場所；無漂浮性的塵埃及金屬微粒之場所；堅固無振動、無電磁雜訊干擾之場所。

## 安裝方向與空間

注意事項：

- 安裝方向必須依規定，否則會造成故障。
- 為了使冷卻循環效果良好，安裝人機介面時，其上下左右與相鄰的物品和擋板(牆)必須保持足夠的空間，否則會造成散熱不良。
- 為確保良好的面板防水，請務必安裝防水墊圈。
- 使用於 Type 4X 室內用等級之外殼平面。
- 安裝面板最大板厚請勿超過 5mm。

安裝示意圖：

步驟一：

請確實將防水墊圈裝入，然後再安裝人機介面

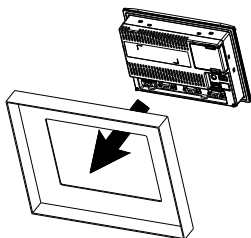

步驟三：

請以 0.7N-M 扭力鎖緊，切記不可超過此扭力，否則將造成塑膠外殼的損壞。

扭力: 6.17lb-inch ( 0.7N-M )

步驟二：

請確實將固定片螺絲組裝入內，然後下方鉤住前蓋螺絲頭頂住控制箱內側

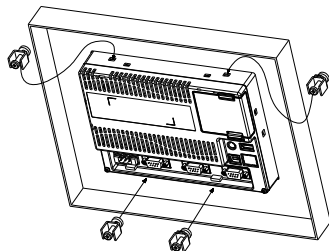

步驟四：

安裝時，人機後方請預留 60mm 散熱空間。

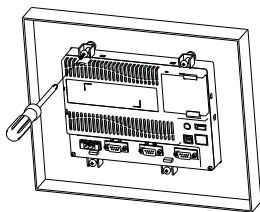

固定螺絲尺寸

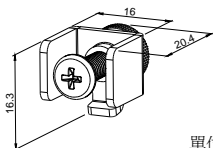

單位：mm

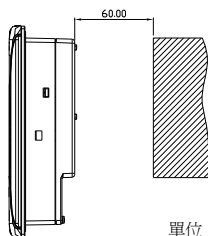

單位：mm

## 配線

注意事項：

- 為避免觸電意外，請勿在開啟電源情況下改變配線。
- 由於人機介面沒有電源開關，請務必安裝一個斷路器開關在人機介面之電源線上。
- 請將電源線絞成雙絞線形式。

建議配線材料如下：

種類	電源配線 ( AWG )	剝線長度	扭力
單芯線	28 ~ 12	7 ~ 8 mm	5 kg-cm ( 4.3 lb-in )
多芯線	30 ~ 12	7 ~ 8 mm	5 kg-cm ( 4.3 lb-in )

請參考下圖電源接頭端子進行配線：

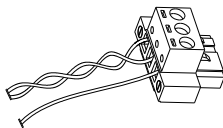

## 基本檢測

檢測項目	檢測內容
一般檢測	<ul style="list-style-type: none"> <li>■ 定期檢查人機介面與設備連接處的螺絲是否有鬆動。</li> <li>■ 排氣孔應避免油、水或金屬粉等異物侵入，且應防止電鑽的切削粉落入人機介面內。</li> <li>■ 人機介面若設置於有害氣體或多粉塵的場所，應防止有害氣體與粉塵的侵入。</li> </ul>
操作前檢測 (未供應控制電源)	<ul style="list-style-type: none"> <li>■ 配線端子的接續部請實施絕緣處理。</li> <li>■ 通訊配線應正確，否則可能發生異常動作。</li> <li>■ 檢查螺絲或金屬片等導電性物體、可燃性物體是否存在人機介面內。</li> <li>■ 人機介面附近使用的電子儀器受到電磁干擾時，請使用儀器調校以降低電磁干擾。</li> <li>■ 請確定人機介面的供應電源電壓準位是否正確。</li> </ul>
運轉前檢測 (已供應控制電源)	<ul style="list-style-type: none"> <li>■ 電源指示燈是否顯示。</li> <li>■ 與各設備之間通訊動作是否正常。</li> <li>■ 人機介面若有異常現象，請洽詢經銷商或者本公司客服中心。</li> </ul>

## 通訊腳位定義

DOP-B07S(E)415 / DOP-B07PS415 / DOP-B08S(E)515 / DOP-B10S(E)615 系列

COM1 定義 (支援流量控制)

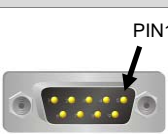
COM Port 示意圖	腳位	說明
		RS-232
	1	
	2	RXD
	3	TXD
	4	
	5	GND
	6	
	7	RTS
	8	CTS
	9	

註：空白 = 不需連接



## COM2 定義 (支援流量控制)

COM Port 示意圖	腳位	MODE1	MODE2	MODE3
		RS-232	RS-422	RS-485
	1		TXD+	D+
	2	RXD		
	3	TXD		
	4		RXD+	
	5	GND	GND	GND
	6		TXD-	D-
	7	RTS		
	8	CTS		
	9		RXD-	

註 1：空白 = 不需連接

註 2：當 COM2 使用 RS-232 流量控制(RTS、CTS 腳位)時，COM3 則無法使用。

註 3：當 COM2 使用 RS-422 流量控制時，其流量控制腳位請參考 COM3 MODE2 括號內的腳位定義。

## COM3 定義

COM Port 示意圖	腳位	MODE1	MODE2	MODE3
		RS-232	RS-422	RS-485
	1		TXD+(RTS+)	D+
	2	RXD		
	3	TXD		
	4		RXD+(CTS+)	
	5	GND	GND	GND
	6		TXD-(RTS-)	D-
	7			
	8			
	9		RXD-(CTS-)	

註 1：空白 = 不需連接

註 2：當 COM2 使用 RS-422 流量控制時，其流量控制腳位請參考 MODE2 括號內的腳位定義。

## 網路埠定義

網路埠示意圖	腳位	說明
		網路埠
	1	TX+
	2	TX-
	3	RX+
	4	
	5	
	6	RX-
	7	
	8	

註：空白 = 不需連接

## DOP-B05 / DOP-B07S(E)515 / DOP-B07PS515 系列

### COM1 定義 (支援流量控制)

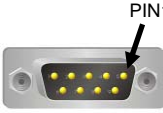
COM Port 示意圖	腳位	說明
		RS-232
	1	
	2	RXD
	3	TXD
	4	
	5	GND
	6	
	7	RTS
	8	CTS
	9	

註：空白 = 不需連接

### COM2、COM3 定義

COM Port 示意圖	腳位	MODE1		MODE2		MODE3	
		COM2	COM3	COM2	COM3	COM2	COM3
		RS-232	RS-485	RS-485	RS-485	RS-232	RS-422
	1			D+			TXD+
	2	RXD				RXD	
	3	TXD				TXD	
	4		D+		D+		RXD+
	5	GND		GND		GND	
	6			D-			TXD-
	7						
	8						
	9		D-		D-		RXD-

註 1：空白 = 不需連接

註 2：B05/B07S(E)515/B07PS515 機種不支援 RS422 流量控制

## 各部位說明

### DOP-B05S100 / DOP-B05S101 (正面)

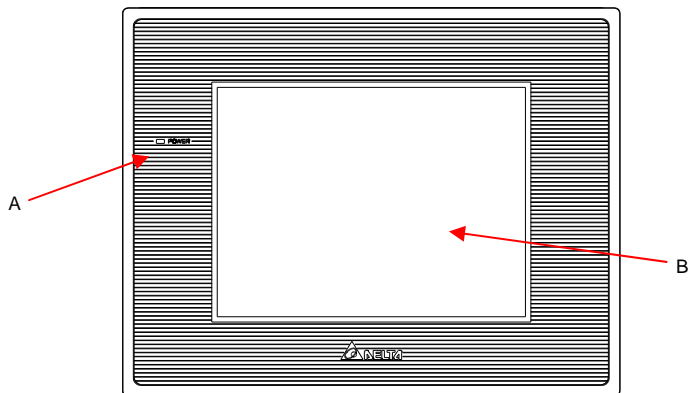

A 電源指示燈 (綠燈亮：正常運作)

B 操作 / 顯示區域

#### DOP-B05S100 / DOP-B05S101 (背面)

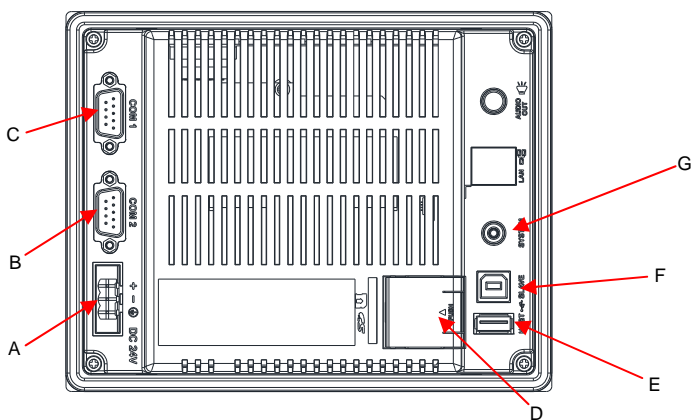

A 電源輸入端子

B COM2 (可擴充 COM3)(註)

C COM1

D 電池外蓋

E USB Host

F USB Slave

G 系統鍵

- -

註：擴充方式請參考通訊腳位定義

DOP-B07S(E)515 / DOP-B07PS515 (正面)

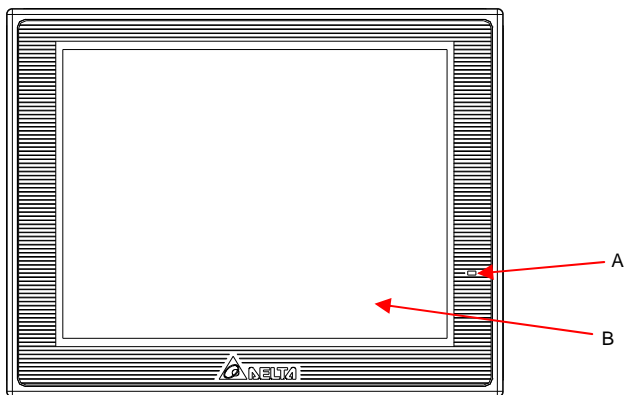

A 電源指示燈 (綠燈亮：正常運作)

B 操作 / 顯示區域

DOP-B07S(E)515 / DOP-B07PS515 (背面)

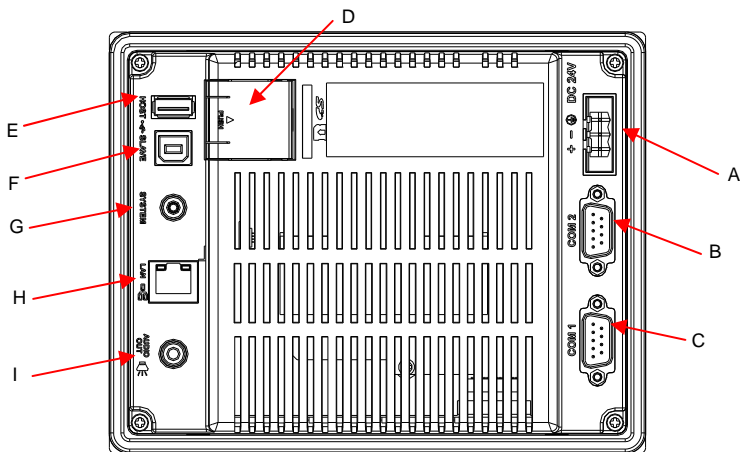

A 電源輸入端子

B COM2 (可擴充 COM3)(註)

C COM1

D 記憶卡插槽 / 電池外蓋

E USB Host

F USB Slave

G 系統鍵

H 網路埠 (LAN)

I 音效輸出埠

註：擴充方式請參考通訊腳位定義

DOP-B07S(E)415 / DOP-B07PS415 (正面)

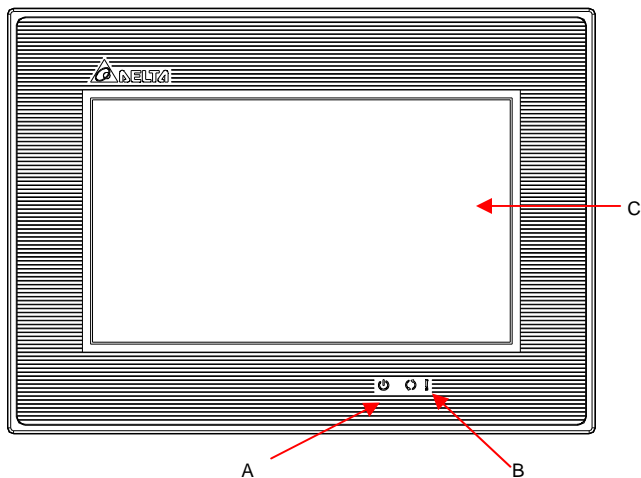

A	電源指示燈 (  )	 綠燈亮：正常運作
B	動作指示燈 (  ) / 警報指示燈 (  )	 藍燈閃爍：通訊中 / 資料存取中 ( 註 )  紅燈閃爍：警報發生中
C	操作/顯示區域	
註：藍色燈號顯示定義可由使用者自行設定		

DOP-B07S(E)415 / DOP-B07PS415 (背面)

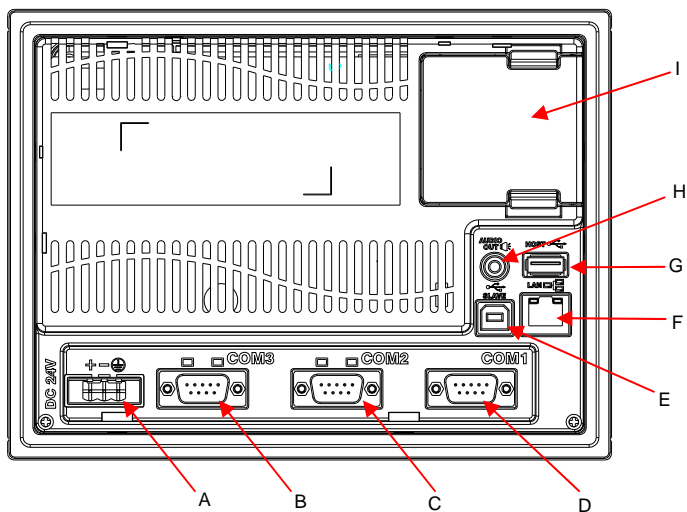

A	電源輸入端子	F	網路埠 (LAN)
B	COM3 (支援通訊狀態指示燈號)	G	USB Host
C	COM2 (支援通訊狀態指示燈號)	H	音效輸出埠
D	COM1	I	記憶卡插槽 / 電池外蓋
E	USB Slave	-	-

DOP-B08S(E)515 (正面)

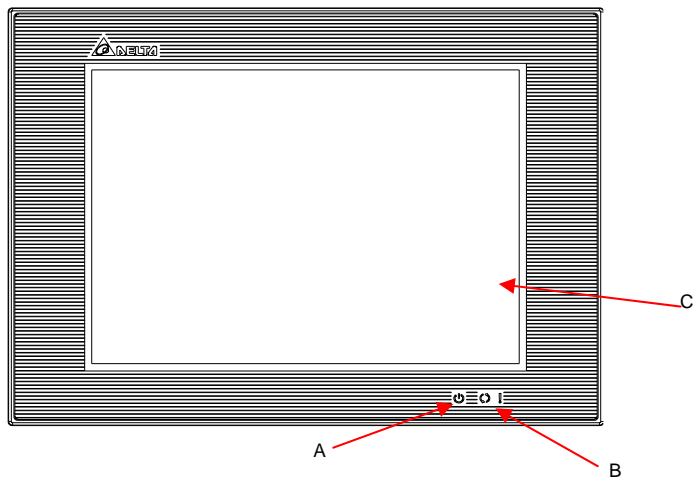

A	電源指示燈 (  )  綠燈亮：正常運作
B	動作指示燈 (  ) / 警報指示燈 (  )  藍燈閃爍：通訊中 / 資料存取中 ( 註 )  紅燈閃爍：警報發生中
C	操作/顯示區域
註：藍色燈號顯示定義可由使用者自行設定	

DOP-B08S(E)515 (背面)

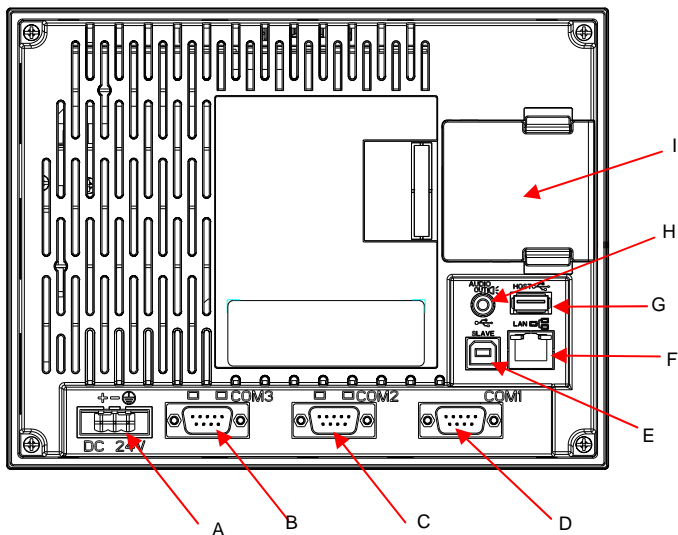

A	電源輸入端子	F	網路埠 ( LAN )
B	COM3 ( 支援通訊狀態指示燈號 )	G	USB Host
C	COM2 ( 支援通訊狀態指示燈號 )	H	音效輸出埠
D	COM1	I	記憶卡插槽 / 電池外蓋
E	USB Slave	-	-



DOP-B10S(E)615 (正面)

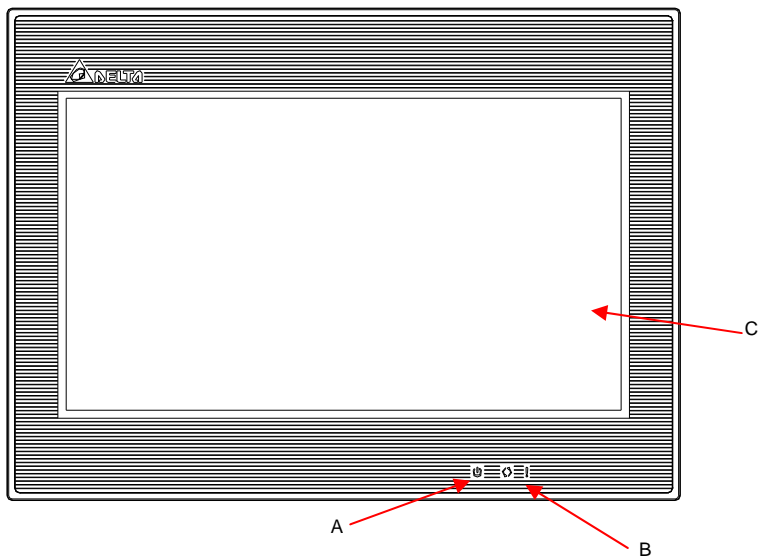

A	電源指示燈 (  )  綠燈亮：正常運作
B	動作指示燈 (  ) / 警報指示燈 (  )  藍燈閃爍：通訊中 / 資料存取中 ( 註 )  紅燈閃爍：警報發生中
C	操作/顯示區域
註：藍色燈號顯示定義可由使用者自行設定	

DOP-B10S(E)615 (背面)

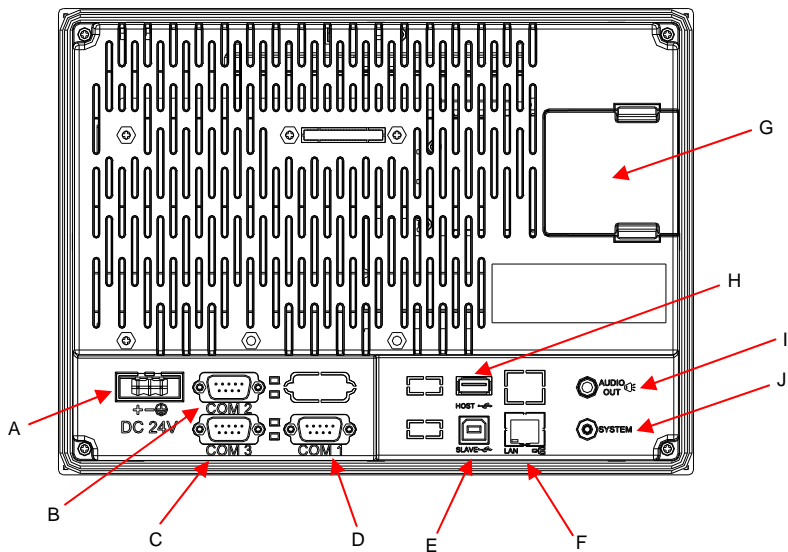

A	電源輸入端子	F	網路埠 (LAN)
B	COM2 (支援通訊狀態指示燈號)	G	記憶卡插槽 / 電池外蓋
C	COM3 (支援通訊狀態指示燈號)	H	USB Host
D	COM1	I	音效輸出埠
E	USB Slave	J	系統鍵

# 開孔尺寸

DOP-B05S100 / DOP-B05S101

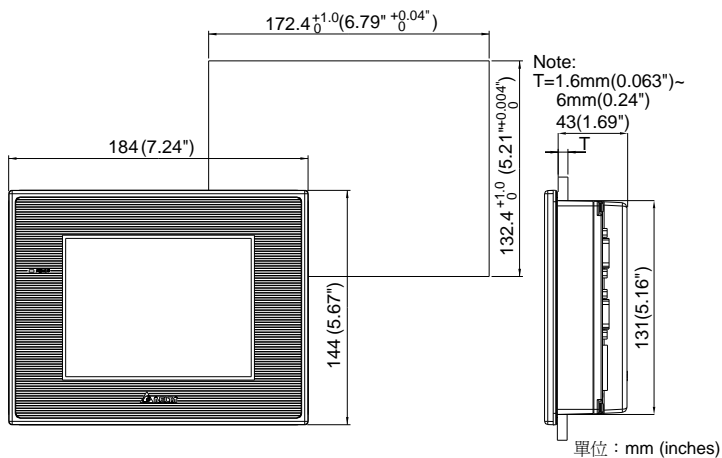

DOP-B07S(E)415 / DOP-B07PS415

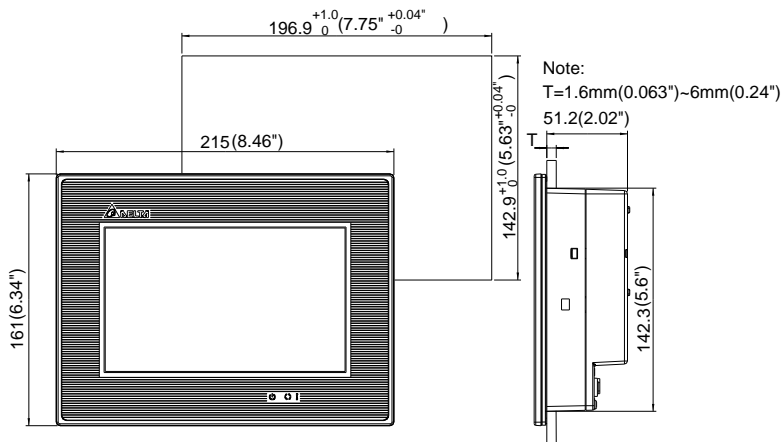

單位：mm (inches)

DOP-B07S(E)515 / DOP-B07PS515

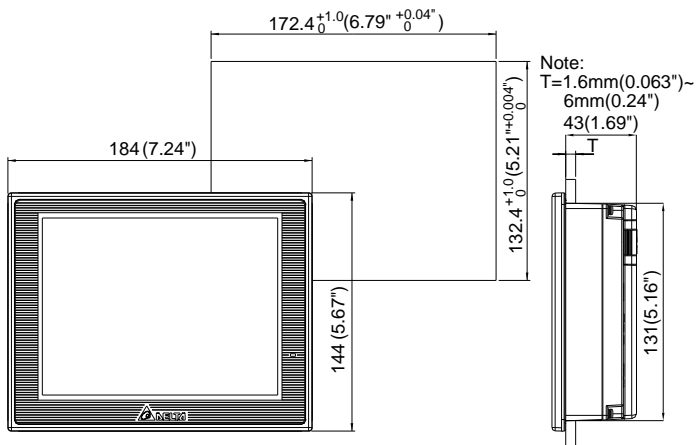

單位：mm (inches)

DOP-B08S(E)515

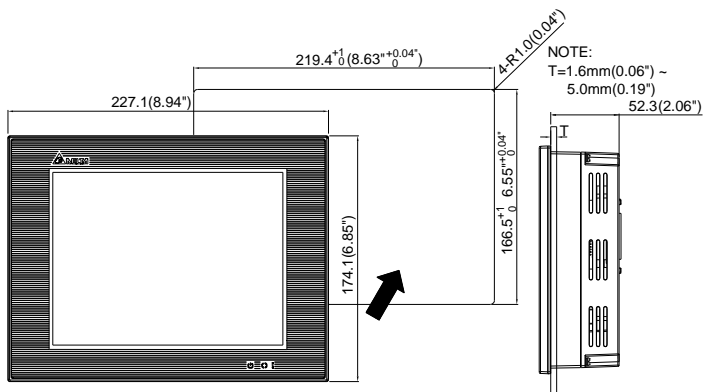

單位：mm (inches)

DOP-B10S(E)615

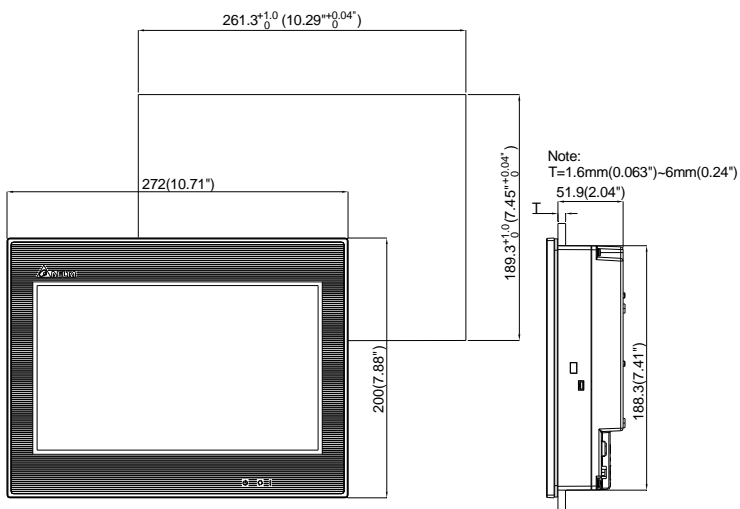

單位：mm (inches)

# 硬體規格

型號		B05S100	B05S101	B07S415	B07E415	B07PS415
顯示器	面板種類	5.6" TFT LCD (65536 色)		7" 寬螢幕 TFT LCD (65536 色)		
	解析度	320 x 234 pixels		800 x 480 pixels		
	背光燈	LED Back Light (常溫 25 <sup>o</sup> C 下半衰期>2 萬小時) <sup>(Note 1)</sup>				
	顯示範圍	113.28 x 84.70mm		152.4 x 91.44mm		
作業系統		Delta Real Time OS				
中央處理器		32-bit RISC Micro-controller				
記憶體 ROM		Flash ROM 4 MB(OS System: 2MB / User Application: 2MB)	Flash ROM 8 MB(OS System: 2MB / User Application: 6MB)	Flash ROM 128 MB (OS System: 30MB / Backup: 16MB / User Application: 82MB)		
SDRAM		8Mbytes	16Mbytes	64Mbytes		
斷電保持內部記憶體 (Bytes)		128Kbytes		16Mbytes		
音效輸出	蜂鳴器	Multi-Tone Frequency ( 2K ~ 4K Hz ) / 85dB				
	AUX	N/A	N/A	N/A	Stereo output	N/A
網路介面		N/A	N/A	N/A	IEEE 802.3, IEEE 802.3u 10/100 Mbps 自動偵測 (內建隔離電路 <sup>(Note 3)</sup> )	N/A
記憶卡		N/A	N/A	SD 卡(支援 SDHC)		
USB		1 USB Host <sup>(Note 2)</sup> Ver 1.1 / 1 USB Slave Ver 1.1		1 USB Host <sup>(Note 2)</sup> Ver 2.0 / 1 USB Slave Ver 1.1		
串列通訊埠	COM1	RS-232 (支援硬體流量控制)				
	COM2	RS-232 / RS-485		RS-232 / RS-422 / RS-485	RS-232 / RS-422 / RS-485 (內建隔離電路 <sup>(Note 3)</sup> )	RS-232 / RS-422 / RS-485

型號		B05S100	B05S101	B07S415	B07E415	B07PS415
COM3		RS-422 / RS-485		RS-232 / RS-422 / RS-485	RS-232 / RS-422 / RS-485 (內建隔離電路 (Note 3))	RS-232 / RS-422 / RS-485
輔助鍵	N/A					
萬年曆	內建					
冷卻方式	自然冷卻					
安規認證	CE / UL (Note 4) / KCC (Note 4)					
面板防水等級	IP65 / NEMA4					
工作電壓 (Note 5)	DC +24V ( -10% ~ +15% ) (請使用隔離式電源供應器)		DC +24V ( -10% ~ +15% ) (請使用隔離式電源供應器)	DC +24V ( -10% ~ +15% ) (內建隔離電路 (Note 3))	DC +24V ( -10% ~ +15% ) (請使用隔離式電源供應器)	
絕緣耐力	DC24V 端子與 FG 端子間：AC500V, 1 分鐘					
消耗功率 (Note 5)	3.0W		5W	7.5W	5W	
記憶體備份電池	3V 鋰電池 CR2032 x 1					
備份電池壽命	依使用環境溫度及使用條件而不同・常溫 25°C 下壽命約三年以上					
操作溫度	0°C ~ 50°C					
儲存溫度	-20°C ~ +60°C					
工作環境	10% ~ 90% RH [ 0 ~ 40°C ] · 10% ~ 55% RH [ 41 ~ 50°C ] · 污染等級 2					
耐震動 / 耐衝擊	IEC61131-2 規定 不連續振動 5Hz-9Hz 3.5mm, 9Hz-150Hz 1G X, Y, Z 各方向 10 次					
尺寸 (W) x (H) x (D) mm	184 x 144 x 50			215 x 161 x 50		
開孔尺寸 (W) x (H) mm	172.4 x 132.4			196.9 x 142.9		
重量	約 670g			約 970g		

 **NOTE**

- 1) 背光模組半衰期的定義：最大驅動電流下，背光亮度衰退到最大亮度的一半時，即為半衰期。所標示之壽命時間為 25 °C 常溫常濕工作環境下之預估值。
- 2) USB Host 最大可提供 5V/ 500mA 電源。
- 3) 隔離電路耐受規格：可承受 1 分鐘 1500V 高壓突波。
- 4) 部份機種認證申請中，詳細認證機種請洽詢各區域代理商。
- 5) 消耗功率為無外接週邊設備時，人機本體所消耗的功率。建議選用的電源供應器容量為標示消耗功率之 1.5~2 倍，以確保人機工作正常。
- 6) DOP-B系列HMI編輯軟體DOPSoft系列及其使用操作手冊，可由台達網站下載取得，網址為 <http://www.delta.com.tw/industrialautomation/>。
- 7) 本人機介面安裝手冊內所記載之規格若有變更，本公司恕不另行通知。當內容規格有所修正時，請洽詢代理商或至台達網站 <http://www.delta.com.tw/industrialautomation/> 下載最新版本。



# 硬體規格

型號		B07S515	B07E515	B07PS515	B08S515	B08E515	B10S615	B10E615
顯示器	面板種類	7" TFT LCD ( 65536 色 )			8" TFT LCD ( 65536 色 )		10.1" 寬螢幕 TFT LCD ( 65536 色 )	
	解析度	800 x 600 pixels			800 x 600 pixels		1024 x 600 pixels	
	背光燈	LED Back Light ( 常溫 25°C 下半衰期 > 1 萬小時 ) (Note 1)						
	顯示範圍	141 x 105.75mm			162 x 121.5mm		226 x 128.7mm	
作業系統		Delta Real Time OS						
中央處理器		32-bit RISC Micro-controller						
記憶體 ROM		Flash ROM 128 MB(OS System: 30MB / Backup: 16MB / User Application: 82MB)						
SDRAM		64Mbytes						
斷電保持內部記憶體 (Bytes)		16Mbytes						
音效輸出	蜂鳴器	Multi-Tone Frequency ( 2K ~ 4K Hz ) / 85dB						
	AUX	N/A	Stereo output	N/A	N/A	Stereo output	N/A	Stereo output
網路介面		N/A	IEEE 802.3, IEEE 802.3u 10/100 Mbps 自動偵測( 內建隔離電路 (Note 3) )	N/A	N/A	IEEE 802.3, IEEE 802.3u 10/100 Mbps 自動偵測( 內建隔離電路 (Note 3) )	N/A	IEEE 802.3, IEEE 802.3u 10/100 Mbps 自動偵測( 內建隔離電路 (Note 3) )
記憶卡		SD 卡(支援 SDHC)						
USB		1 USB Host (Note 2) Ver 2.0 / 1 USB Slave Ver 1.1						
串列通訊埠	COM1	RS-232 ( 支援硬體流量控制 )						
	COM2	RS-232 / RS-485	RS-232 / RS-485 ( 內建隔離電路 (Note 3) )	RS-232 / RS-485	RS-232 / RS-422 / RS-485	RS-232 / RS-422 / RS-485 ( 內建隔離電路 (Note 3) )	RS-232 / RS-422 / RS-485	RS-232 / RS-422 / RS-485 ( 內建隔離電路 (Note 3) )
	COM3	RS-422 / RS-485	RS-422 / RS-485 ( 內建隔離電路 (Note 3) )	RS-422 / RS-485	RS-232 / RS-422 / RS-485	RS-232 / RS-422 / RS-485 ( 內建隔離電路 (Note 3) )	RS-232 / RS-422 / RS-485	RS-232 / RS-422 / RS-485 ( 內建隔離電路 (Note 3) )
輔助鍵		N/A						
萬年曆		內建						
冷卻方式		自然冷卻						

型號	B07S515	B07E515	B07PS515	B08S515	B08E515	B10S615	B10E615
安規認證	CE / UL <sup>(Note 4)</sup> / KCC <sup>(Note 4)</sup>						
面板防水等級	IP65 / NEMA4						
工作電壓 (Note 5)	DC +24V (-10% ~ +15%) (請使用 隔離式電 源供應器)	DC +24V (-10% ~ +15%) (內建隔離電 路 <sup>(Note 3)</sup> )	DC +24V (-10% ~ +15%) (請 使用隔離式 電源供應器)	DC +24V (-10% ~ +15%) (請 使用隔離式 電源供應器)	DC +24V (-10% ~ +15%) (內建隔離 電路 <sup>(Note 3)</sup> )	DC +24V (-10% ~ +15%) (內建隔離電路 <sup>(Note 3)</sup> )	
絕緣耐力	DC24V 端子與 FG 端子間：AC500V, 1 分鐘						
消耗功率 (Note 5)	7.68W			5.2W	7.8W	12W	
記憶體備份電池	3V 鋰電池 CR2032 x 1						
備份電池壽命	依使用環境溫度及使用條件而不同・常溫 25°C 下壽命約三年以上						
操作溫度	0°C ~ 50°C						
儲存溫度	-20°C ~ +60°C						
工作環境	10% ~ 90% RH [0 ~ 40°C]・10% ~ 55% RH [41 ~ 50°C]・污染等級 2						
耐震動 / 耐衝擊	IEC61131-2 規定 不連續振動 5Hz-9Hz 3.5mm, 9Hz-150Hz 1G 連續振動 5Hz-9Hz 1.75mm, 9Hz-150Hz 0.5G X, Y, Z 各方向 10 次						
尺寸 (W) x (H) x (D) mm	184 x 144 x 50			227.1 x 174.1 x 61		272 x 200 x 61	
開孔尺寸 (W) x (H) mm	172.4 x 132.4			219.4 X 166.5		261.3 X 189.3	
重量	約 800g			約 1226g		約 1520g	



- 1) 背光模組半衰期的定義：最大驅動電流下，背光亮度衰退到最大亮度的一半時，即為半衰期。  
所標示之壽命時間為 25 °C 常溫常濕工作環境下之預估值。
- 2) USB Host 最大可提供 5V/ 500mA 電源。
- 3) 隔離電路耐受規格：可承受 1 分鐘 1500V 高壓突波。
- 4) 部份機種認證申請中，詳細認證機種請洽詢各區域代理商。
- 5) 消耗功率為無外接週邊設備時，人機本體所消耗的功率。建議選用的電源供應器容量為標示消耗功率之 1.5~2 倍，以確保人機工作正常。
- 6) DOP-B系列HMI編輯軟體DOPSoft系列及其使用操作手冊，可由台達網站下載取得，網址為 <http://www.delta.com.tw/industrialautomation/>。
- 7) 本人機介面安裝手冊內所記載之規格若有變更，本公司恕不另行通知。當內容規格有所修正時，請洽詢代理商或至台達網站 <http://www.delta.com.tw/industrialautomation/> 下載最新版本。

感谢您使用本产品，本人机界面安装手册提供 DOP-B 系列人机界面的相关信息。在使用之前，请您仔细阅读本手册以确保使用上的正确。此外，请妥善将其放置在明显的地点以便随时查阅。下列事项在您尚未读完本手册前，请务必遵守：

- 安装的环境必须没有水气，腐蚀性气体及可燃性气体。
- 接线时，请依接线图说明施工。
- 接地工程必须确实实施，接地时须遵照国家现行相关电工法规的规定施行（请参考 NFPA 70: National Electrical Code, 2005 Ed.）。
- 在通电时，请勿拆解人机界面或更改配线。
- 在通电运作时，请勿接触电源处，以免触电。

如果您在使用上仍有问题，请洽询经销商或者本公司客服中心。由于产品精益求精，当内容规格有所修正时，请洽询代理商或至达网站（<http://www.delta.com.tw/industrialautomation/>）下载最新版本。

## 安全注意事项

安装、配线、操作、维护及检查时，应随时注意以下安全注意事项。

### 安装注意

- 
- 依照手册指定的方式安装人机界面，否则可能导致设备损坏。
  - 禁止将本产品暴露在有水气、腐蚀性气体、可燃性气体等物质的场所下使用，否则可能会造成触电、火灾或爆炸。
  - 请勿将人机界面安装在超过规格范围的温度环境中，否则可能造成人机界面无法正常运作或损坏。
  - 本产品为 KCC Class A（商用设备）产品且通过试验认证，其设计的目的是在商业或是工业环境使用，而非家庭环境中使用。若在此情况下不小心购买或售出人机界面产品，请将其更换为有符合 KCC Class B（家用设备）认证的产品。
  - 请勿将人机界面用于可能会造成人员伤亡、设备损坏或系统停机等警报机台。

### 配线注意

- 
- 请将接地端子连接到 class-3（100 Ω 以下）接地，接地不良可能会造成通讯异常、触电或火灾。

### 操作注意

- 
- 人机界面需配合编辑软件规划画面，未经规划或确认的人机界面可能会导致不正常运转结果。为避免操作人身伤害或设备损坏，规划人机画面时，要确保人机界面及其连接控制器或设备之间的通讯故障不会造成设备功能无法正常运作。
  - 为避免预防意外遗失程序，请务必备份规划好的人机界面画面程序。



- 不得在开启电源情况下改变配线，否则可能造成触电或人员受伤。
- 请勿以尖锐物品碰触面板，否则可能导致面板凹陷，进而使人机界面无法正常工作。

## 保养及检查



- 禁止接触人机界面内部，否则可能会造成触电。
- 电源启动时，禁止拆下人机界面面板，否则可能会造成触电。
- 电源关闭 10 分钟内，不得接触接线端子，残余电压可能造成触电。
- 更换备用电池时，应切断电源再进行，并在更换后重新检查系统设定值。
- 人机界面在操作时，排气孔不可封住，否则人机容易因为散热不良而造成故障。

## 配线方法



- 请勿使用超过人机界面规格范围的电压，否则可能会引起触电或火灾。
- 配线时请将快速接头从人机界面的本体上拆下来。
- 快速接头的—个电线插入口，请仅插入—根电线。
- 对于错误强行拔出电线的动作，请重新检查连接电线再启动。

## 通讯电路的配线



- 请依标准规格采用通讯配线线材。
- 通讯线材长度需在符合规定内。
- 采用正确的接地回路，以避免通讯不良。
- 为防止较大的杂波干扰引起 人机界面无法正常工作，请用单独的配线槽将人机界面的通讯电缆和所有电源线及马达动力线分开。

## 安装环境条件

本产品在安装之前必须置于其包装箱内，若暂时不使用，为了使该产品能够符合本公司的质保范围及日后的维护，储存时务必注意下列事项：

- 必须置于无尘垢、干燥的位置。
- 储存位置的环境温度必须在 $-20^{\circ}\text{C}$  to  $+60^{\circ}\text{C}$  ( $-4^{\circ}\text{F}$  to  $140^{\circ}\text{F}$ ) 范围内。
- 储存位置的相对湿度必须在 10%到 90%范围内，且无结露。
- 避免储存在含有腐蚀性气、液体之环境中。
- 最好适当包装存放在架子或台面。
- 本产品适合的安装环境包括有：无发高热装置的场所；无水滴、蒸气、灰尘及油性灰尘的场所；无腐蚀、易燃性气、液体的场所；无漂浮性的尘埃及金属微粒的场所；坚固无振动、无电磁杂波干扰的场所。

## 安装方向与空间

注意事项:

- 安装方向必须依规定，否则会造成故障。
- 为了使冷却循环效果良好，安装人机界面时，其上下左右与相邻的物品和挡板(墙)必须保持足够的空间，否则会造成散热不良。
- 为确保良好的面板防水，请务必安装防水垫圈。
- 使用在 Type 4X 室内用等级的外壳平面。
- 安装面板最大板厚请勿超过 5mm。

安装示意图:

步骤一:

请确实将防水垫圈装入，然后再安装人机界面

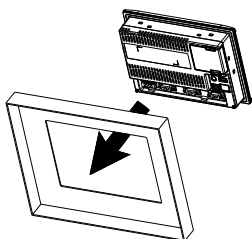

步骤二:

请确实将固定片螺丝组装入内，然后下方钩住前盖螺丝头顶住控制箱内侧

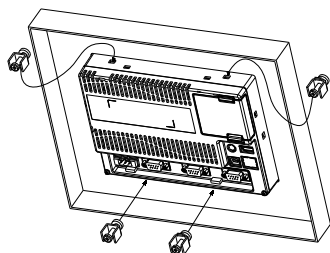

步骤三:

请以 0.7N-M 扭力锁紧，切记不可超过此扭力，否则将造成塑胶外壳的损坏。

扭力: 6.17lb-inch (0.7N-M)

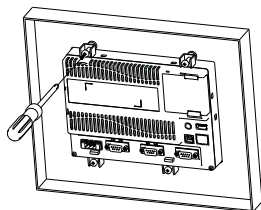

步骤四:

安装时，人机后方请预留 60mm 散热空间。

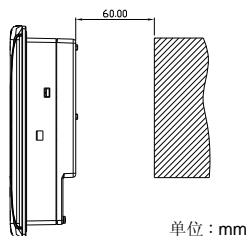

固定螺丝尺寸

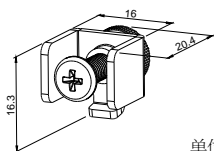

单位: mm

## 配线

注意事项:

- 为避免触电意外, 请勿在开启电源情况下改变配线。
- 由于人机界面没有电源开关, 请务必安装一个断路器开关在人机界面的电源线上。
- 请将电源线绞成双绞线形式。

建议配线材料如下:

种类	电源配线 (AWG)	剥线长度	扭力
单芯线	28 ~ 12	7 ~ 8 mm	5 kg-cm (4.3 lb-in)
多芯线	30 ~ 12	7 ~ 8 mm	5 kg-cm (4.3 lb-in)

请参考下图电源接头端子进行配线:

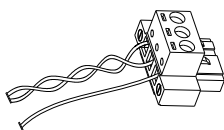

## 基本检测

检测项目	检测内容
一般检测	<ul style="list-style-type: none"><li>■ 定期检查人机界面与设备连接处的螺丝是否有松动。</li><li>■ 排气孔应避免油、水或金属粉等异物侵入, 且应防止电钻的切削粉落入人机界面内。</li><li>■ 人机界面若设置于有害气体或多粉尘的场所, 应防止有害气体与粉尘的侵入。</li></ul>
操作前检测 (未供应控制电源)	<ul style="list-style-type: none"><li>■ 配线端子的接续部请实施绝缘处理。</li><li>■ 通讯配线应正确, 否则可能发生异常动作。</li><li>■ 检查螺丝或金属片等导电性物体、可燃性物体是否存在人机界面内。</li><li>■ 人机界面附近使用的电子仪器受到电磁干扰时, 请使用仪器调校以降低电磁干扰。</li><li>■ 请确定人机界面的供应电源电压准位是否正确。</li></ul>
运转前检测 (已供应控制电源)	<ul style="list-style-type: none"><li>■ 电源指示灯是否显示。</li><li>■ 与各设备之间通讯动作是否正常。</li><li>■ 人机界面若有异常现象, 请洽询经销商或者本公司客服中心。</li></ul>

## 通讯引脚定义

DOP-B07S(E)415 / DOP-B07PS415 / DOP-B08S(E)515 / DOP-B10S(E)615 系列

### COM1 定义 (支持流量控制)

COM Port 示意图	引脚	说明
		RS-232
	1	
	2	RXD
	3	TXD
	4	
	5	GND
	6	
	7	RTS
	8	CTS
	9	

注: 空白=不需连接

### COM2 定义 (支持流量控制)

COM Port 示意图	引脚	MODE1	MODE2	MODE3
		RS-232	RS-422	RS-485
	1		TXD+	D+
	2	RXD		
	3	TXD		
	4		RXD+	
	5	GND	GND	GND
	6		TXD-	D-
	7	RTS		
	8	CTS		
	9		RXD-	

注 1: 空白=不需连接

注 2: 当 COM2 使用 RS-232 流量控制(RTS、CTS 引脚)时, COM3 则无法使用。

注 3: 当 COM2 使用 RS-422 流量控制时, 其流量控制引脚请参考 COM3 MODE2 括号内的引脚定义。

### COM3 定义

COM Port 示意图	引脚	MODE1	MODE2	MODE3
		RS-232	RS-422	RS-485
	1		TXD+(RTS+)	D+
	2	RXD		
	3	TXD		
	4		RXD+(CTS+)	
	5	GND	GND	GND
	6		TXD-(RTS-)	D-
	7			
	8			
	9		RXD-(CTS-)	

注 1: 空白=不需连接

注 2: 当 COM2 使用 RS-422 流量控制时, 其流量控制引脚请参考 MODE2 括号内的引脚定义。



## 网络端口定义

网络端口示意图	引脚	说明
		网络端口
	1	TX+
	2	TX-
	3	RX+
	4	
	5	
	6	RX-
	7	
	8	

注：空白=不需连接

## DOP-B05 / DOP-B07S(E)515 / DOP-B07PS515 系列

### COM1 定义（支持流量控制）

COM Port 示意图	引脚	说明
		RS-232
	1	
	2	RXD
	3	TXD
	4	
	5	GND
	6	
	7	RTS
	8	CTS
	9	

注：空白=不需连接

### COM2、COM3 定义

COM Port 示意图	引脚	MODE1		MODE2		MODE3	
		COM2	COM3	COM2	COM3	COM2	COM3
		RS-232	RS-485	RS-485	RS-485	RS-232	RS-422
	1			D+			TXD+
	2	RXD				RXD	
	3	TXD				TXD	
	4		D+		D+		RXD+
	5	GND		GND		GND	
	6			D-			TXD-
	7						
	8						
	9		D-		D-		RXD-

注 1：空白=不需连接

注 2：B05/B07S(E)515/B07PS515 机种不支持 RS422 流量控制

## 各部位说明

### DOP-B05S100 / DOP-B05S101 (正面)

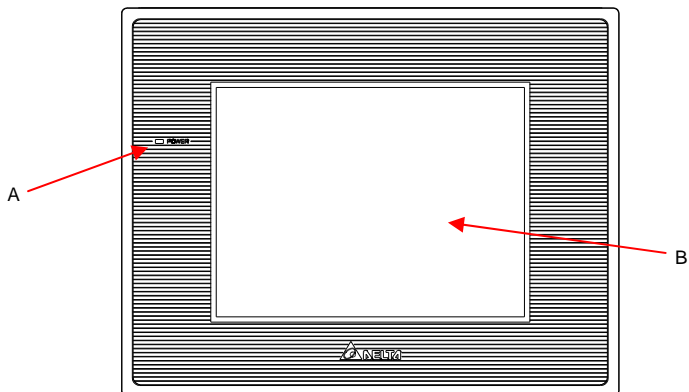

- |   |                   |
|---|-------------------|
| A | 电源指示灯 (绿灯亮: 正常运作) |
| B | 操作 / 显示区域         |

### DOP-B05S100 / DOP-B05S101 (背面)

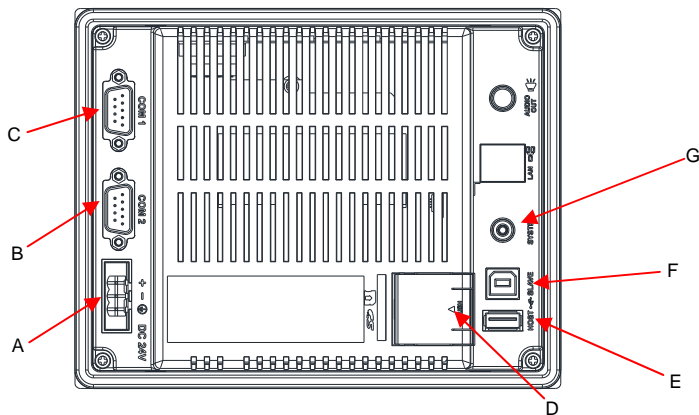

A	电源输入端子	E	USB Host
B	COM2 (可扩展 COM3) (注)	F	USB Client
C	COM1	G	系统键
D	电池外盖		

注: 扩展方式请参考通讯引脚定义

## DOP-B07S(E)515 / DOP-B07PS515 (正面)

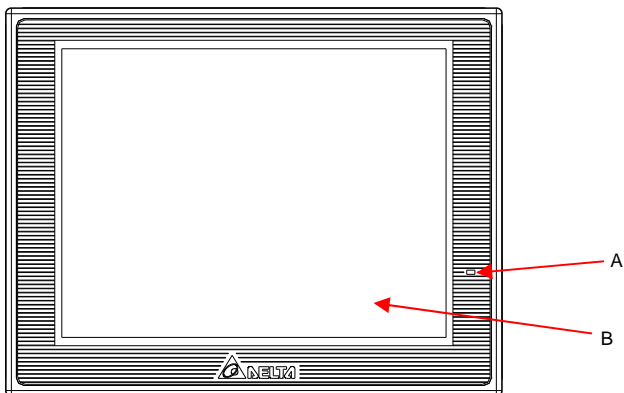

A 电源指示灯 (绿灯亮: 正常运作)

B 操作 / 显示区域

## DOP-B07S(E)515 / DOP-B07PS515 (背面)

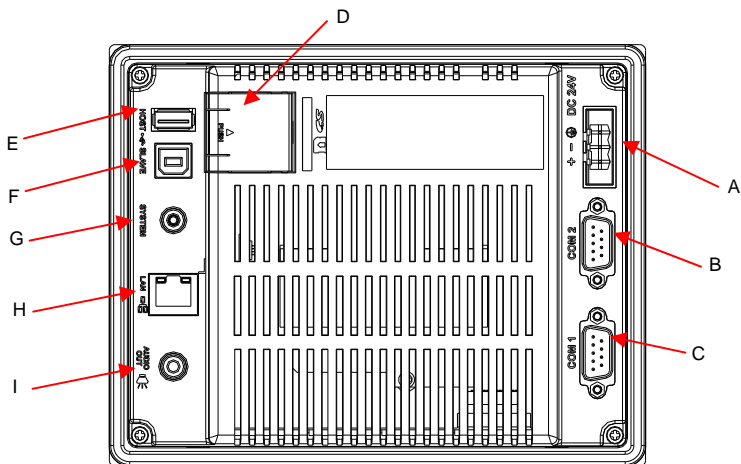

A 电源输入端子

B COM2 (可扩展 COM3) (注)

C COM1

D 存储卡插槽 / 电池外盖

E USB Host

注: 扩展方式请参考通讯引脚定义

F USB Client

G 系统键

H 网络端口 (LAN)

I 音效输出端口

DOP-B07S(E)415 / DOP-B07PS415 (正面)

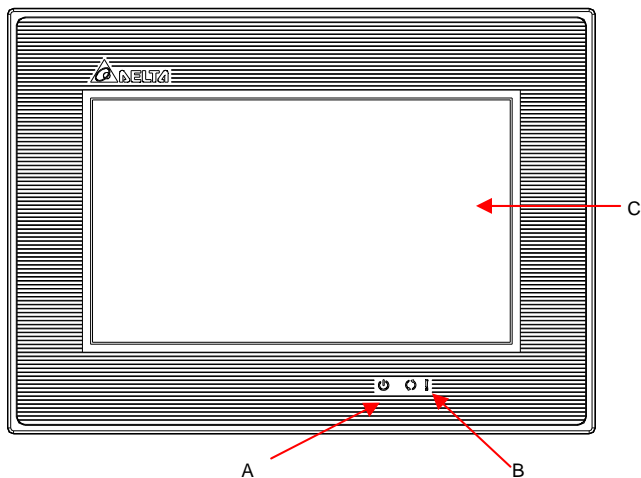

A	电源指示灯 (  )	 绿灯亮：正常运作
B	动作指示灯(  ) / 警报指示灯(  )	 蓝灯闪烁：通讯中 / 数据存取中 (注)  红灯闪烁：警报发生中
C	操作/显示区域	
注：蓝色灯号显示定义可由使用者自行设定		

DOP-B07S(E)415 / DOP-B07PS415 (背面)

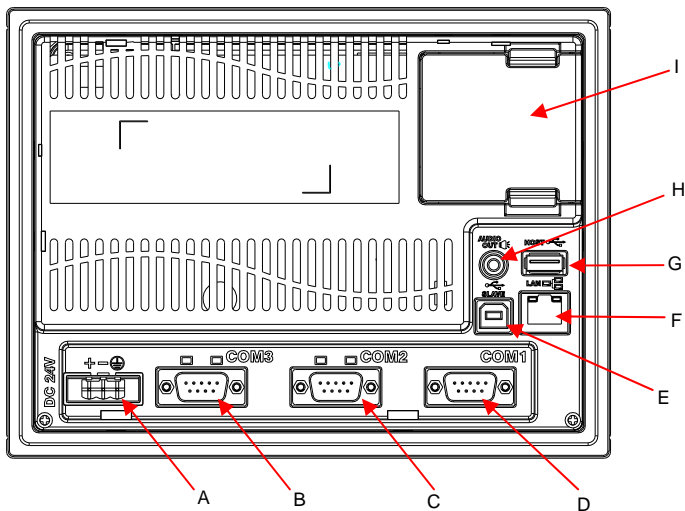

A	电源输入端子	F	网络端口 (LAN)
B	COM3 (支持通讯状态指示灯号)	G	USB Host
C	COM2 (支持通讯状态指示灯号)	H	音效输出端口
D	COM1	I	存储卡插槽 / 电池外盖
E	USB Client	-	-

DOP-B08S(E)515 (正面)

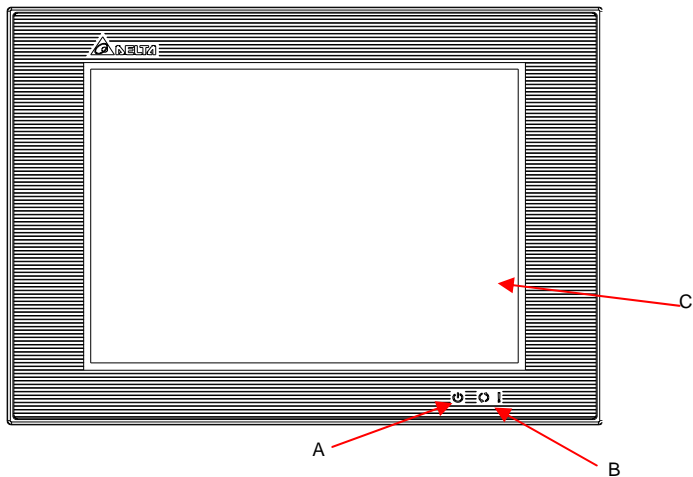

A	电源指示灯 (  )	 绿灯亮: 正常运作
B	动作指示灯(  ) / 警报指示灯(  )	 蓝灯闪烁: 通讯中 / 数据存取中 (注)  红灯闪烁: 警报发生中
C	操作/显示区域	

注: 蓝色灯号显示定义可由使用者自行设定

# DOP-B08S(E)515 (背面)

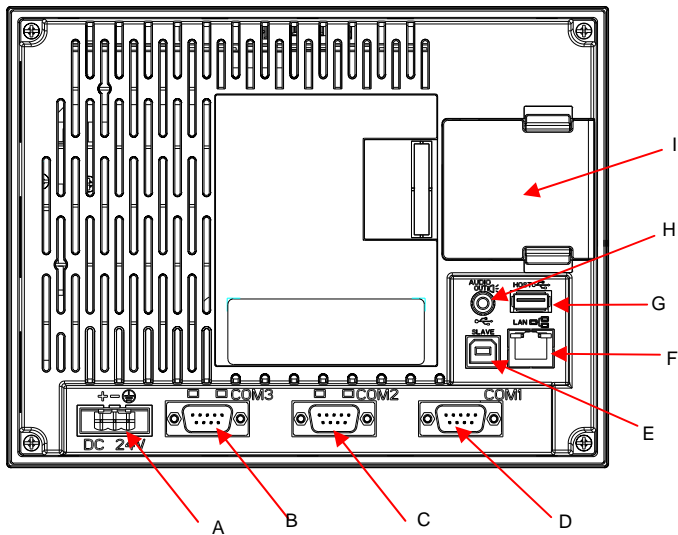

A	电源输入端子	F	网络端口 (LAN)
B	COM3 (支持通讯状态指示灯号)	G	USB Host
C	COM2 (支持通讯状态指示灯号)	H	音效输出端口
D	COM1	I	存储卡插槽 / 电池外盖
E	USB Client	-	-

DOP-B10S(E)615 (正面)

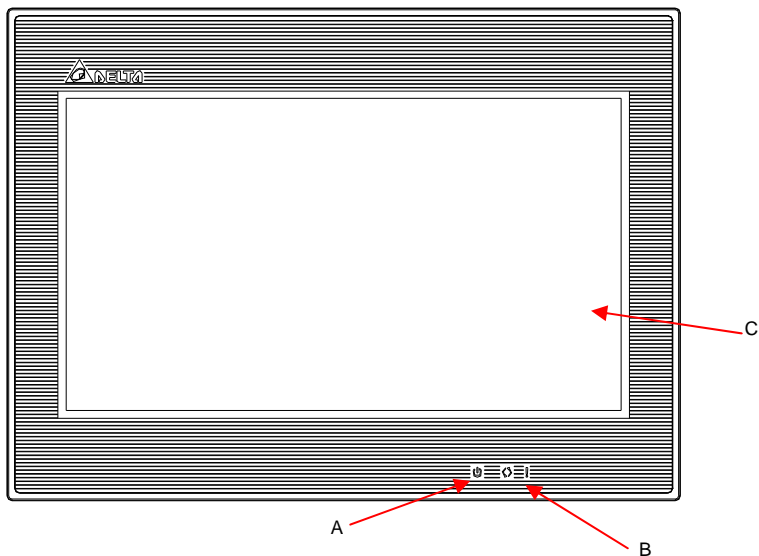

A	电源指示灯 (  )	 绿灯亮：正常运作
B	动作指示灯(  ) / 警报指示灯(  )	 蓝灯闪烁：通讯中 / 数据存取中 (注)  红灯闪烁：警报发生中
C	操作/显示区域	
注：蓝色灯号显示定义可由使用者自行设定		



DOP-B10S(E)615 (背面)

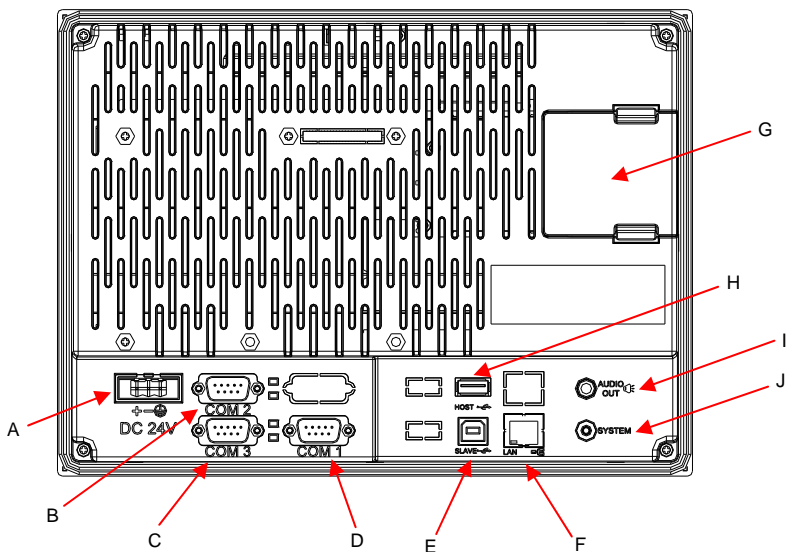

A	电源输入端子	F	网络端口 (LAN)
B	COM2 (支持通讯状态指示灯)	G	存储卡插槽 / 电池外盖
C	COM3 (支持通讯状态指示灯)	H	USB Host
D	COM1	I	音效输出端口
E	USB Client	J	系统键

# 开孔尺寸

DOP-B05S100 / DOP-B05S101

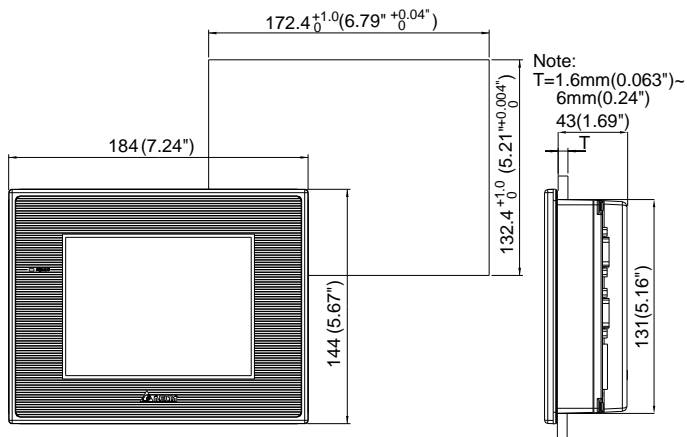

DOP-B07S(E)415 / DOP-B07PS415

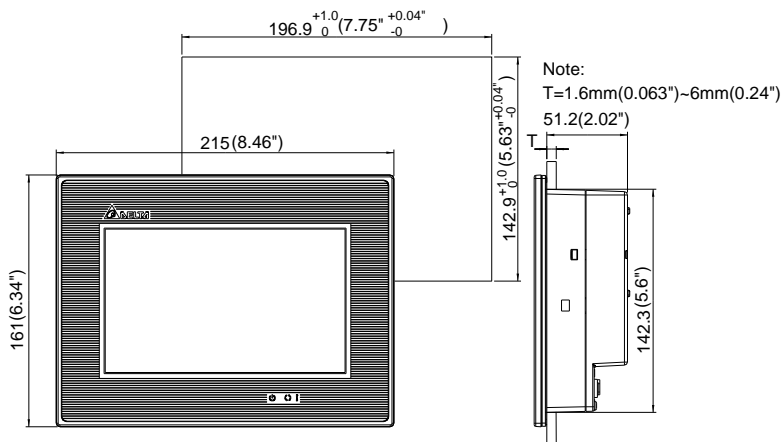

单位：mm (inches)

DOP-B07S(E)515 / DOP-B07PS515

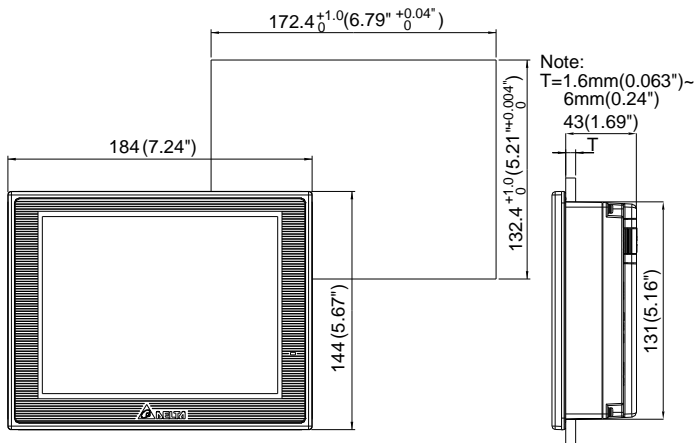

单位：mm (inches)

DOP-B08S(E)515

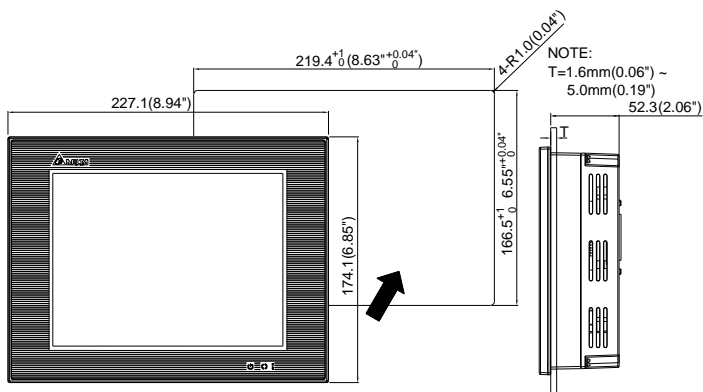

单位：mm (inches)

DOP-B10S(E)615

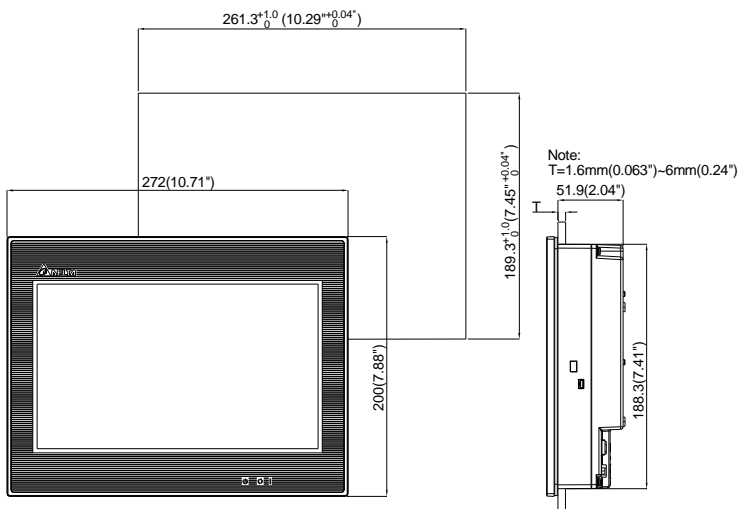

单位：mm (inches)

## 硬件规格

型号		B05S100	B05S101	B07S415	B07E415	B07PS415
显示器	面板种类	5.6" TFT LCD (65536 色)		7" 宽屏 TFT LCD (65536 色)		
	分辨率	320 x 234 pixels		800 x 480 pixels		
	背光灯	LED Back Light (常温 25°C 下半衰期>2 万小时) <sup>(Note 1)</sup>				
	显示范围	113.28 x 84.70mm		152.4 x 91.44mm		
操作系统	Delta Real Time OS					
中央处理器	32-bit RISC Micro-controller					
内存 ROM	Flash ROM 4 MB(OS System: 2MB / User Application: 2MB)	Flash ROM 8 MB(OS System: 2MB / User Application: 6MB)	Flash ROM 128 MB (OS System: 30MB / Backup: 16MB / User Application: 82MB)			
SDRAM	8Mbytes	16Mbytes	64Mbytes			
断电保持内部存储器 (Bytes)	128Kbytes		16Mbytes			
音效输出	蜂鸣器	Multi-Tone Frequency ( 2K ~ 4K Hz ) / 85dB				
	AUX	N/A	N/A	N/A	Stereo output	N/A
网络界面	N/A	N/A	N/A	IEEE 802.3, IEEE 802.3u	N/A	
				10/100 Mbps 自动侦测 (内置隔离电路 <sup>(Note 3)</sup> )		
存储卡	N/A	N/A	SD 卡(支持 SDHC)			
USB	1 USB Host <sup>(Note 2)</sup> Ver 1.1 / 1 USB Slave Ver 1.1		1 USB Host <sup>(Note 2)</sup> Ver 2.0 / 1 USB Slave Ver 1.1			
串行通讯端口	COM1	RS-232 (支持硬件流量控制)				
	COM2	RS-232 / RS-485		RS-232 / RS-422 / RS-485	RS-232 / RS-422 / RS-485 (内置隔离电路 <sup>(Note 3)</sup> )	RS-232 / RS-422 / RS-485
	COM3	RS-422 / RS-485		RS-232 / RS-422 / RS-485	RS-232 / RS-422 / RS-485 (内置隔离电路 <sup>(Note 3)</sup> )	RS-232 / RS-422 / RS-485
辅助键	N/A					
万年历	内置					
冷却方式	自然冷却					
安规认证	CE / UL <sup>(Note 4)</sup> / KCC <sup>(Note 4)</sup>					

型号	B05S100	B05S101	B07S415	B07E415	B07PS415
面板防水等级	IP65 / NEMA4				
工作电压 (Note 5)	DC +24V (-10% ~ +15%) (请使用 隔离式电源供应器)		DC +24V (-10% ~ +15%) (请使用隔离 式电源供应器)	DC +24V (-10% ~ +15%) (内置隔离电路 (Note 3))	DC +24V (-10% ~ +15%) (请使用隔 离式电源供应器)
绝缘耐力	DC24V 端子与 FG 端子间: AC500V, 1 分钟				
消耗功率 (Note 5)	3.0W		5W	7.5W	5W
内存备份电池	3V 锂电池 CR2032 x 1				
备份电池寿命	依使用环境温度及使用条件而不同, 常温 25°C 下寿命约三年以上				
操作温度	0°C ~ 50°C				
储存温度	-20°C ~ +60°C				
工作环境	10% ~ 90% RH 【0 ~ 40°C】, 10% ~ 55% RH 【41 ~ 50°C】, 污染等级 2				
耐震动 / 耐冲击	IEC61131-2 规定 不连续振动 5Hz-9Hz 3.5mm, 9Hz-150Hz 1G 连续振动 5Hz-9Hz 1.75mm, 9Hz-150Hz 0.5G X, Y, Z 各方向 10 次				
尺寸 (W) x (H) x (D) mm	184 x 144 x 50		215 x 161 x 50		
开孔尺寸 (W) x (H) mm	172.4 x 132.4		196.9 x 142.9		
重量	约 670g		约 970g		

## NOTE

- 1) 背光模块半衰期的定义: 最大驱动电流下, 背光亮度衰退到最大亮度的一半时, 即为半衰期。所标示的寿命时间为 25°C 常温常湿工作环境下的预估值。
- 2) USB Host 最大可提供 5V/ 500mA 电源。
- 3) 隔离电路耐受规格: 可承受 1 分钟 1500V 高压突波。
- 4) 部份機種认证申请中, 详细认证機種请洽询各区域代理商。
- 5) 消耗功率为无外接周边设备时, 人机本体所消耗的功率。建议选用的电源供应器容量为标示消耗功率的 1.5~2 倍, 以确保人机工作正常。
- 6) DOP-B 系列 HMI 编辑软件 DOPSoft 系列及其使用操作手册, 可由台达网站下载取得, 网址为 <http://www.delta.com.tw/industrialautomation/>。
- 7) 本人机界面安装手册内所记载的规格若有变更, 本公司恕不另行通知。当内容规格有所修正时, 请洽询代理商或至台达网站 <http://www.delta.com.tw/industrialautomation/> 下载最新版本。

## 硬件规格

型号	B07S515	B07E515	B07PS515	B08S515	B08E515	B10S615	B10E615	
显示器	面板种类	7" TFT LCD (65536 色)			8" TFT LCD (65536 色)		10.1" 宽屏 TFT LCD (65536 色)	
	分辨率	800 x 600 pixels			800 x 600 pixels		1024 x 600 pixels	
	背光灯	LED Back Light (常温 25°C 下半衰期 > 1 万小时) <sup>(Note 1)</sup>						
	显示范围	141 x 105.75mm			162 x 121.5mm		226 x 128.7mm	
操作系统	Delta Real Time OS							
中央处理器	32-bit RISC Micro-controller							
内存 ROM	Flash ROM 128 MB(OS System: 30MB / Backup: 16MB / User Application: 82MB)			Flash ROM 128 MB(OS System: 30MB / Backup: 16MB / User Application: 82MB)		Flash ROM 128 MB(OS System: 30MB / Backup: 16MB / User Application: 82MB)		
SDRAM	64Mbytes							
断电保持内部存储器 (Bytes)	16Mbytes							
音效输出	蜂鸣器	Multi-Tone Frequency ( 2K ~ 4K Hz ) / 85dB						
	AUX	N/A	Stereo output	N/A	N/A	Stereo output	N/A	Stereo output
网络界面	N/A	IEEE 802.3, IEEE 802.3u	N/A	N/A	IEEE 802.3, IEEE 802.3u	N/A	IEEE 802.3, IEEE 802.3u	
		10/100 Mbps 自动侦测 (内置隔离电路 <sup>(Note 3)</sup> )			10/100 Mbps 自动侦测 (内置隔离电路 <sup>(Note 3)</sup> )		10/100 Mbps 自动侦测 (内置隔离电路 <sup>(Note 3)</sup> )	
存储卡	SD 卡 (支持 SDHC)							
USB	1 USB Host <sup>(Note 2)</sup> Ver 2.0 / 1 USB Slave Ver 1.1							
串行通讯端口	COM1	RS-232 (支持硬件流量控制)						
	COM2	RS-232 / RS-485	RS-232 / RS-485 (内置隔离电路 <sup>(Note 3)</sup> )	RS-232 / RS-485	RS-232 / RS-422 / RS-485	RS-232 / RS-422 / RS-485 (内置隔离电路 <sup>(Note 3)</sup> )	RS-232 / RS-422 / RS-485	RS-232 / RS-422 / RS-485 (内置隔离电路 <sup>(Note 3)</sup> )
	COM3	RS-422 / RS-485	RS-422 / RS-485 (内置隔离电路 <sup>(Note 3)</sup> )	RS-422 / RS-485	RS-232 / RS-422 / RS-485	RS-232 / RS-422 / RS-485 (内置隔离电路 <sup>(Note 3)</sup> )	RS-232 / RS-422 / RS-485	RS-232 / RS-422 / RS-485 (内置隔离电路 <sup>(Note 3)</sup> )
辅助键	N/A							
万年历	内置							
冷却方式	自然冷却							

型号	B07S515	B07E515	B07PS515	B08S515	B08E515	B10S615	B10E615
安规认证	CE / UL <sup>(Note 4)</sup> / KCC <sup>(Note 4)</sup>						
面板防水等级	IP65 / NEMA4						
工作电压 (Note 5)	DC +24V (-10% ~ +15%) (请 使用隔离式 电源供应器)	DC +24V (-10% ~ +15%) (内置隔离 电路 <sup>(Note 3)</sup> )	DC +24V (-10% ~ +15%) (请 使用隔离式 电源供应器)	DC +24V (-10% ~ +15%) (请 使用隔离式 电源供应器)	DC +24V (-10% ~ +15%) (内置隔离 电路 <sup>(Note 3)</sup> )	DC +24V (-10% ~ +15%) (内置隔离电路 <sup>(Note 3)</sup> )	
绝缘耐力	DC24V 端子与 FG 端子间: AC500V, 1 分钟						
消耗功率 (Note 5)	7.68W			5.2W	7.8W	12W	
内存备份电池	3V 锂电池 CR2032 x 1						
备份电池寿命	依使用环境温度及使用条件而不同, 常温 25°C 下寿命约三年以上						
操作温度	0°C ~ 50°C						
储存温度	-20°C ~ +60°C						
工作环境	10% ~ 90% RH 【0 ~ 40°C】, 10% ~ 55% RH 【41 ~ 50°C】, 污染等级 2						
耐震动 / 耐冲击	IEC61131-2 规定 不连续振动 5Hz-9Hz 3.5mm, 9Hz-150Hz 1G 连续振动 5Hz-9Hz 1.75mm, 9Hz-150Hz 0.5G X, Y, Z 各方向 10 次						
尺寸 (W) x (H) x (D) mm	184 x 144 x 50			227.1 x 174.1 x 61		272 x 200 x 61	
开孔尺寸 (W) x (H) mm	172.4 x 132.4			219.4 X 166.5		261.3 X 189.3	
重量	约 800g			约 1226g		约 1520g	

## NOTE

- 背光模块半衰期的定义: 最大驱动电流下, 背光亮度衰退到最大亮度的一半时, 即为半衰期。  
所标示的使用寿命为 25°C 常温常湿工作环境下的预估值。
- USB Host 最大可提供 5V/ 500mA 电源。
- 隔离电路耐受规格: 可承受 1 分钟 1500V 高压突波。
- 部份机种认证申请中, 详细认证机种请洽各区域代理商。
- 消耗功率为无外接周边设备时, 人机本体所消耗的功率。建议选用的电源供应器容量为标示消耗功率的 1.5~2 倍, 以确保人机工作正常。
- DOP-B 系列 HMI 编辑软件 DOPSoft 系列及其使用操作手册, 可由台达网站下载取得, 网址为 <http://www.delta.com.tw/industrialautomation/>。
- 本人机界面安装手册内所记载的规格若有变更, 本公司恕不另行通知。当内容规格有所修正时, 请洽询代理商或至台达网站 <http://www.delta.com.tw/industrialautomation/> 下载最新版本。