



## LNP-0501 Series

**5-Port Industrial PoE+ Unmanaged Ethernet Switches with  
4\*10/100Tx (30W/Port) + 1\*10/100Tx**



## User Manual

Version 2.1



**© Copyright 2018 Antaira Technologies, LLC**

All Rights Reserved

This document contains information, which is protected by copyright. Reproduction, adaptation or translation without prior permission is prohibited, except as allowed under the copyright laws.

**Trademark Information**

Antaira is a registered trademark of Antaira Technologies, LLC, Microsoft Windows and the Windows logo are the trademarks of Microsoft Corp. NetWare is the registered trademark of Novell Inc. WMM and WPA are the registered trademarks of Wi-Fi Alliance. All other brand and product names are trademarks or registered trademarks of their respective owners.

**Notice:** Copyrights © 2018 by Antaira Technologies, LLC. All rights reserved. Reproduction, adaptation, or translation without prior permission of Antaira Technologies, LLC is prohibited, except as allowed under the copyright laws.

**Disclaimer**

Antaira Technologies, LLC provides this manual without warranty of any kind, expressed or implied, including but not limited to the implied warranties of merchantability and fitness for a particular purpose. Antaira Technologies, LLC may make improvements and/or changes to the product and/or specifications of the product described in this manual, without prior notice. Antaira Technologies, LLC will not be liable for any technical inaccuracies or typographical errors found in this guide. Changes are periodically made to the information contained herein and will be incorporated into later versions of the manual. The information contained is subject to change without prior notice.

## FCC Notice

This equipment has been tested and found to comply with the limits for a Class-A digital device, pursuant to Part 15 of the FCC rules. These limits are designed to provide reasonable protection against harmful interference in a residential installation. This equipment generates, uses, and can radiate radio frequency energy. It may cause harmful interference to radio communications if the equipment is not installed and used in accordance with the instructions. However, there is no guarantee that interference will not occur in a particular installation. If this equipment does cause harmful interference to radio or television reception, which can be determined by turning the equipment off and on, the user is encouraged to try to correct the interference by one or more of the following measures:

- Reorient or relocate the receiving antenna.
- Increase the separation between the equipment and receiver.
- Connect the equipment into an outlet on a circuit different from that to which the receiver is connected.
- Consult the dealer or an experienced radio/TV technician for help.

**Caution:** Any changes or modifications not expressly approved by the grantee of this device could void the user's authority to operate the equipment.

## CE Mark Warning

This is a Class-A product. In a domestic environment this product may cause radio interference in which case the user may be required to take adequate measures.

## Industrial Ethernet Switches

Industrial Grade Unmanaged Ethernet Switches

User Manual

Version 2.1 (March 2018)

This manual supports the following models:

- LNP-0501-M
- LNP-0501-M-T
- LNP-0501-ST-M
- LNP-0501-ST-M-T
- LNP-0501-S3
- LNP-0501-S3-T
- LNP-0501-ST-S3
- LNP-0501-ST-S3-T

This document is the current official release manual. Please check our website ([www.antaira.com](http://www.antaira.com)) for any updated manual or contact us by e-mail ([support@antaira.com](mailto:support@antaira.com)).

# Table of Contents

<b>1. Overview .....</b>	<b>1</b>
1.1 Key Features.....	1
1.2 Package Contents.....	2
1.3 Safety Precaution.....	2
<b>2. Hardware Description .....</b>	<b>3</b>
2.1 Physical Dimensions.....	3
2.2 Front Panel .....	4
2.3 Top View .....	4
2.4 LED Indicators .....	5
2.5 Ethernet Ports .....	5
2.6 Cabling.....	7
2.7 Wiring the Power Inputs.....	8
2.8 Wiring the Fault Alarm Contact .....	9
<b>3. Mounting Installation .....</b>	<b>10</b>
3.1 DIN-Rail Mounting.....	10
3.2 Wall Mounting .....	12
<b>4. Hardware Installation .....</b>	<b>13</b>
4.1 Installation Steps.....	13
<b>5. Network Application .....</b>	<b>14</b>
<b>6. Trouble Shooting.....</b>	<b>15</b>
<b>7. Technical Specifications .....</b>	<b>16</b>

# 1. Overview

**Antaira Technologies' LNP-0501 series** is an industrial PoE+ unmanaged Ethernet switch featuring 4\*10/100Tx Fast Ethernet RJ45 ports and 1\*100Fx fiber port with SC or ST type connectors and an option for multi-mode (2Km) or single-mode (30Km). Each Ethernet port supports an IEEE 802.3at high power PoE+ output up to 30W per port, making it ideal for applications that demand a PoE power source and a long distance data communication within any harsh or outdoor environment. This product series provides high EFT and ESD protection to prevent any unregulated voltage.

The LNP-0501 series is IP30 rated and DIN-rail mountable. There are two wide operating temperature models for either a standard temperature range (STD: -10°C to 70°C) or an extended temperature range (EOT: -40°C to 75°C).

It also provides Ethernet connectivity with PoE functions and a fiber connection for outdoor or harsh industrial automation application environments, such as, security surveillance, ITS-traffic monitoring systems, oil/gas and mining, facility management for power/utility, water wastewater treatment plants, and lastly, automated production lines in factory automation.

## 1.1 Key Features

- System Interface/Performance
  - All RJ-45 ports support the auto MDI/MDI-X function
  - Embedded 4\*10/100Tx (PSE 30W/Port), 1\*100Fx SC/ST type connector (Multi-mode 2Km, or Single-mode 30Km)
  - Store-and-forward switching architecture
  - 2K MAC address table
  - Power line EFT protection: 2,000VDC; Ethernet ESD protection: 6,000VDC
- Power Input
  - DC 48~55V redundant power, with a 6-pin removal terminal block
- Operating Temperature
  - Standard operating temperature model: -10°C ~ 70°C
  - Extended operating temperature model (-T): -40°C ~ 75°C
- Case/Installation
  - IP-30 protection
  - DIN-Rail and wall mount design

## 1.2 Package Contents

- 1 - LNP-0501 (T): 5-port industrial PoE+ unmanaged Ethernet switch with 4\*10/100Tx (30W/port), 1\*100Fx Fiber SC/ST type connector (Multi-mode 2Km, or Single-mode 30Km)
- 1 - User manual
- 1 - Product CD
- 2 - Wall mounting brackets and screws
- 1 - DC cable –18 AWG & DC jack 5.5x2.1mm

## 1.3 Safety Precaution

**Attention:** If the DC voltage is supplied by an external circuit, please use a protection device on the power supply input. The industrial Ethernet switch's hardware specs, ports, cabling information, and wiring installation will be described within this user manual.

## 2. Hardware Description

### 2.1 Physical Dimensions

Figure 2.1, below, shows the physical dimensions of Antaira Technologies' LNP-0501 series: 5-port industrial PoE+ unmanaged Ethernet switch with 4\*10/100Tx (30W/port), 1\*100Fx Fiber SC/ST type connector (Multi-mode 2Km, or Single-mode 30Km).

(W x D x H) is **30mm x 99mm x 142mm**

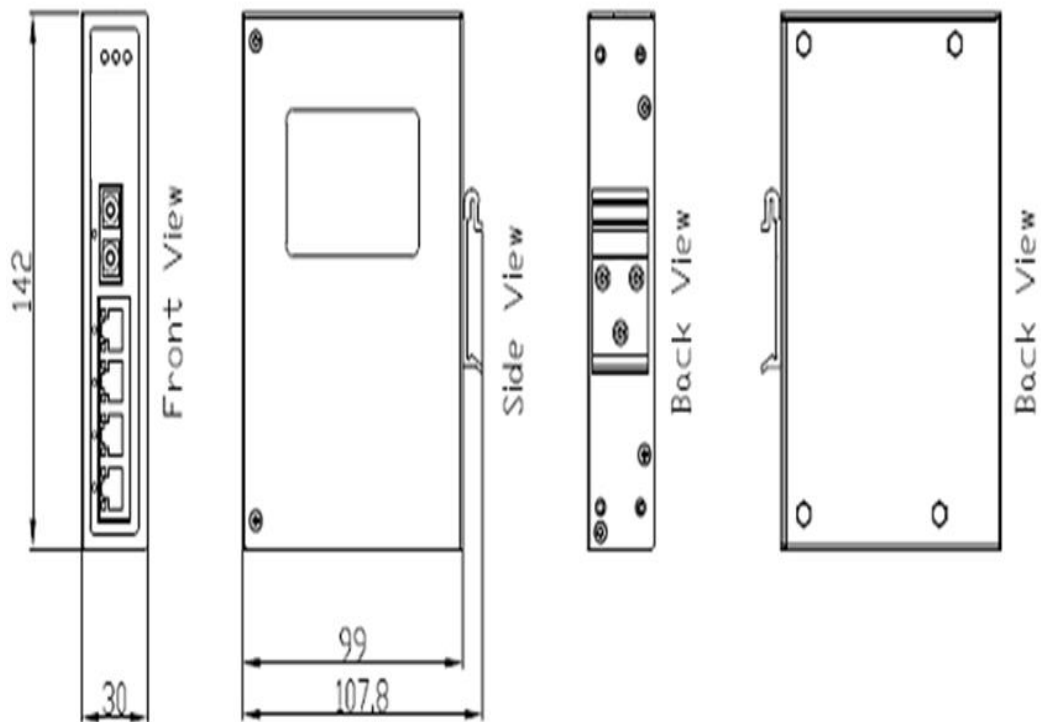
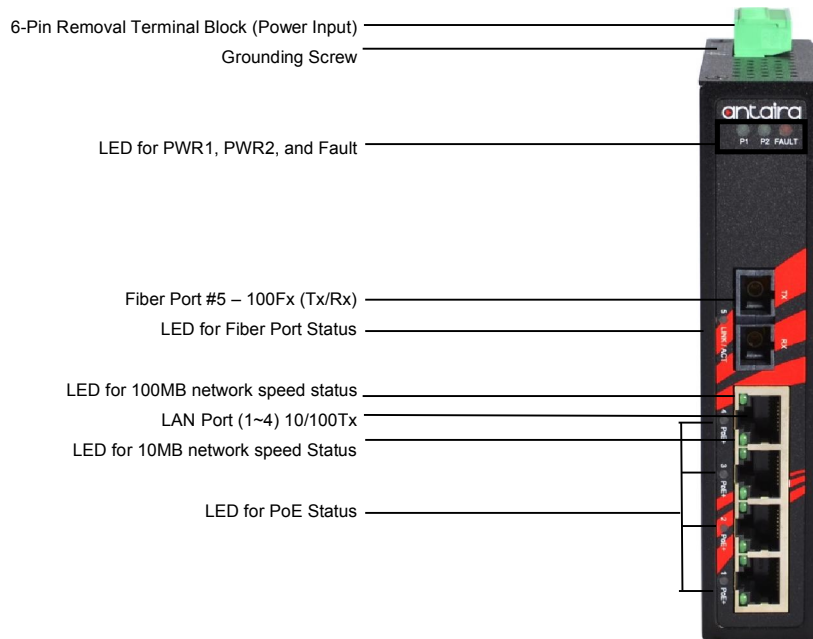

Figure 2.1

LNP-0501 Series Physical Dimensions

## 2.2 Front Panel

The front panel of the LNP-0501 series: 5-port industrial PoE+ unmanaged Ethernet switch with 4\*10/100Tx (30W/port), 1\*100Fx Fiber SC/ST type connector (Multi-mode 2Km, or Single-mode 30Km) is shown below in *Figure 2.2*.



*Figure 2.2 - Front Panel of the LNP-0501 Series*

## 2.3 Top View

*Figure 2.3*, below, shows the top panel of the LNP-0501 series switch that is equipped with one 6-pin removal terminal block connector for dual DC power inputs (48-55 VDC).

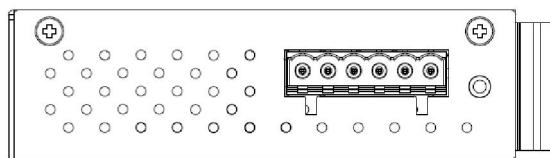

*Figure 2.3*  
*Top Panel View of LNP-0501 Series*



## 2.4 LED Indicators

There are LED light indicators located on the front panel of the industrial Ethernet switch that display the power status and network status. Each LED indicator has a different color and has its own specific meaning, see below in *Table 2.1*.



LED	Color	Description	
P1	Green	On	Power input 1 is active
		Off	Power input 1 is inactive
P2	Green	On	Power input 2 is active
		Off	Power input 2 is inactive
Fault	Red	On	Power input 1 or 2 is inactive
		Off	Power input 1 and 2 are both functional, or no power inputs
PoE Indicators (Port 1~4)	Green	On	The port is supplying PoE power
		Off	No powered-device attached or power supplying fails
LAN Port 1 ~ 4 (Upper LED)	 Green	On	Connected to network, 100Mbps
		Flashing	Networking is active
		Off	Not connected to network
LAN Port 1 ~ 4 (Lower LED)	 Green	On	Connected to network, 10Mbps
		Flashing	Networking is active
		Off	Not connected to network
Fiber Port	Green	On	Connected to network, 100Mbps
		Flashing	Networking is active
		Off	Not connected to network

Table 2.1

LED Indicators for LNP-0501 Series

## 2.5 Ethernet Ports

### ■ RJ-45 Ports

**RJ-45 Ports (Auto MDI/MDIX):** The RJ-45 ports (LAN 1~4) are auto-sensing for 10Base-T, or 100Base-Tx devices connections. Auto MDI/MDIX means that the switch can connect to another switch or workstation without changing the straight-through or crossover cabling. See the figures shown below for straight-through and crossover cabling schematics.

■ RJ-45 Pin Assignments (Table 2.2)

Pin Number	Assignment
1	Rx+
2	Rx-
3	Tx+
6	Tx-

Table 2.2  
RJ45 Pin Assignments

**Note:** The “+” and “-” signs represent the polarity of the wires that make up each wire pair.

All ports on this industrial Ethernet switch support automatic MDI/MDI-X operations. Users can use straight-through cables (see figure below) for all network connections to PCs, servers, and other switches or hubs. With straight-through cable, pins 1, 2, 3, and 6, at one end of the cable, are connected straight through to pins 1, 2, 3 and 6 at the other end of the cable. The table below (Table 2.3) shows the 10BASE-T/100BASE-TX/1000BASE-T MDI and MDI-X port pin outs.

Pin MDI-X	Signal Name	MDI Signal Name
1	Receive Data plus (RD+)	Transmit Data plus (TD+)
2	Receive Data minus (RD-)	Transmit Data minus (TD-)
3	Transmit Data plus (TD+)	Receive Data plus (RD+)
6	Transmit Data minus (TD-)	Receive Data minus (RD-)

Table 2.3  
Ethernet Signal Pin Outs

The following figures show the cabling schematics for straight-through and crossover cables.

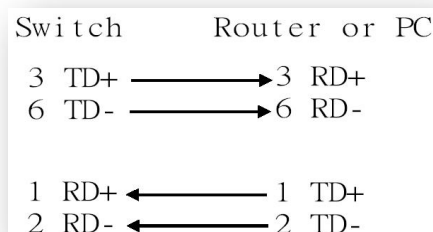

Figure 2.4 - Straight-Through Cables Schematic

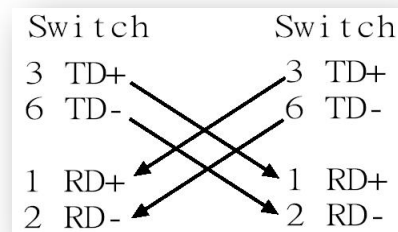

Figure 2.5 - Crossover Cables Schematic

## ■ Fiber Port

The fiber port of SC type connector can work in multi-mode or single-mode. When connecting the fiber port to another one, please connect accordingly by following the figure below. The wrong connection will cause the port to not work normally.

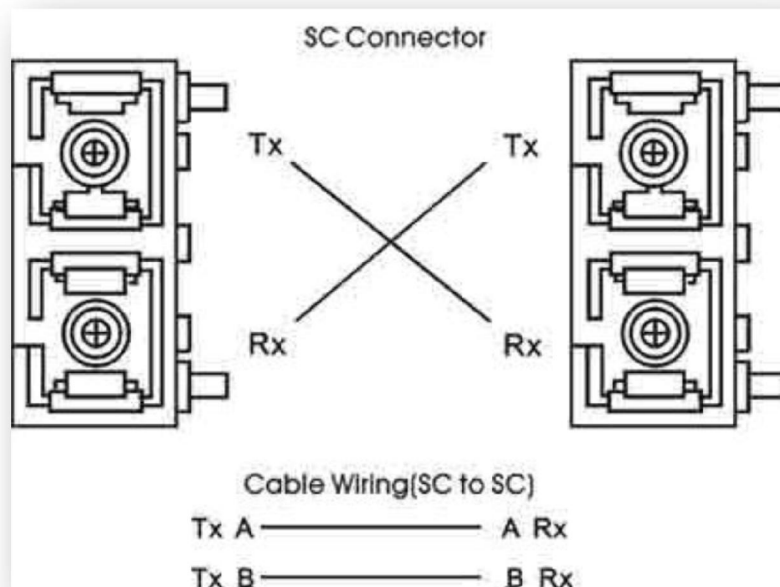

Figure 2.6 – Fiber Port Cabling

### \*\*ATTENTION

This is a Class 1 Laser/LED product. Don't stare into the Laser/LED beam.

## 2.6 Cabling

- Twisted-pair segments can be connected with an unshielded twisted pair (UTP) or shielded twisted pair (STP) cable. The cable must comply with the IEEE 802.3u 100Base TX standard (e.g. Category 5, 5e, or 6). The cable between the equipment and the link partner (switch, hub, workstation, etc.) must be less than 100 meters (328 ft.) long.
  - Fiber segment using **single-mode** connector type must use 9/125µm single-mode fiber cable.
  - Fiber segment using **multi-mode** connector type must use 50 or 62.5/125 µm multi-mode fiber cable.

## 2.7 Wiring the Power Inputs

Please follow the below steps to insert the power wire.

1. Insert the positive and negative wires into the PWR1 (V1+, V1-) and PWR2 (V2+, V2-) contacts on the terminal block connector as shown below in *Figure 2.7*.

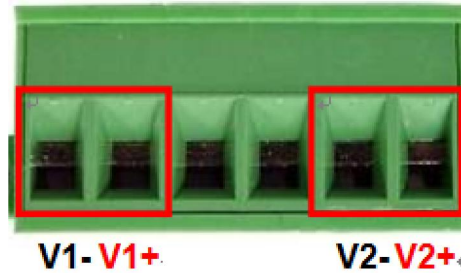

*Figure 2.7*

*Power Terminal Block*

2. Tighten the wire-clamp screws to prevent the wires from loosening, as shown below in *Figure 2.8*.

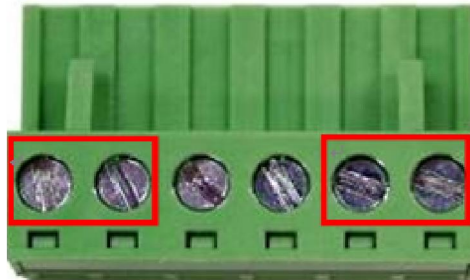

*Figure 2.8*

*Power Terminal Block*

- 
- \*\*Note:**
- Only use copper conductors, 60/75°C, tighten to 5 lbs.
  - The wire gauge for the terminal block should range between 18~20 AWG.
-

## 2.8 Wiring the Fault Alarm Contact

The fault alarm contact is in the middle of the terminal block connector as the picture shows below in *Figure 2.9*. By inserting the wires, it will detect the fault status including power failure or port link failure (managed industrial switch only) and form a normal open circuit. An example is shown below in *Figure 2.9*.

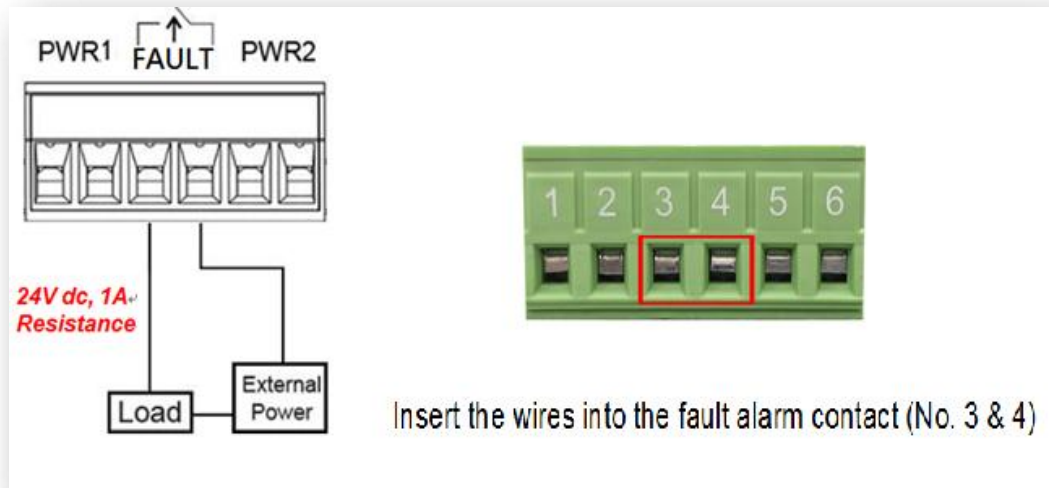

Figure 2.9

Wiring the Fault Alarm Contact

- 
- \*\*Note:**
- The wire gauge for the terminal block should range between 12 ~ 24 AWG.
  - If only using one power source, jumper Pin 1 to Pin 5 and Pin 2 to Pin 6 to eliminate power fault alarm.
-

## 3. Mounting Installation

### 3.1 DIN-Rail Mounting

The DIN-Rail is pre-installed on the industrial Ethernet switch from the factory. If the DIN-Rail is not on the industrial Ethernet switch, please refer to Figure 3.1 to learn how to install the DIN-Rail on the switch.

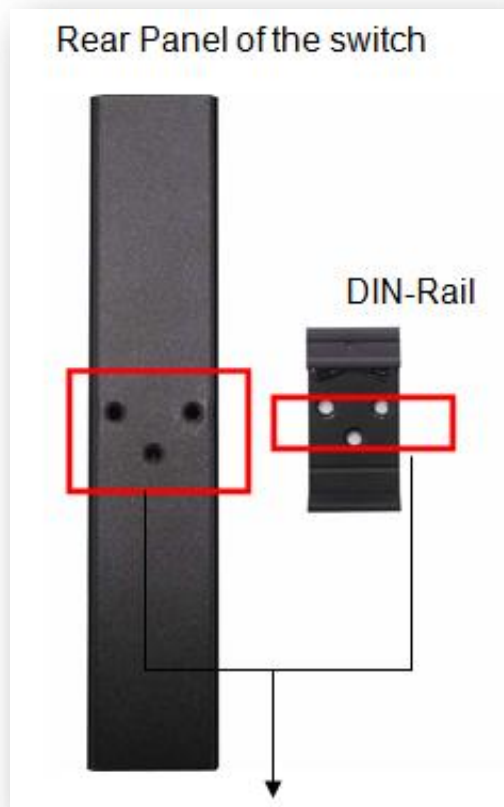

Figure 3.1

*The Rear Side of the Switch and DIN-Rail Bracket*

Follow the steps below to learn how to hang the industrial Ethernet switch.

1. Use the screws to install the DIN-Rail bracket on the rear side of the industrial Ethernet switch.
2. To remove the DIN-Rail bracket, do the opposite from step 1.
3. After the DIN-Rail bracket is installed on the rear side of the switch, insert the top of the DIN-Rail on to the track as shown below in *Figure 3.2*.



*Figure 3.2*

*Insert the Switch on the DIN-Rail*

4. Lightly pull down the bracket on to the rail as shown below in *Figure 3.3*.

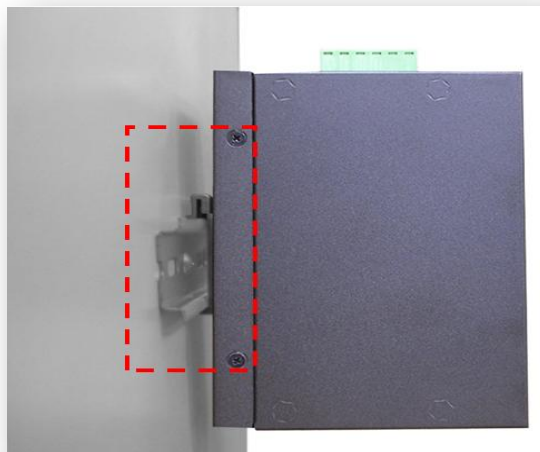

*Figure 3.3*

*Stable the Switch on DIN-Rail*

5. Check if the bracket is mounted tightly on the rail.
6. To remove the industrial Ethernet switch from the rail, do the opposite from the above steps.

## 3.2 Wall Mounting

Follow the steps below to mount the industrial Ethernet switch using the wall mounting bracket as shown below in *Figure 3.4*.

1. Remove the DIN-Rail bracket from the industrial Ethernet switch by loosening the screws.
2. Place the wall mounting brackets on the top and bottom of the industrial Ethernet switch.
3. Use the screws to screw the wall mounting bracket on the industrial Ethernet switch.
4. Use the hook holes at the corners of the wall mounting bracket to hang the industrial Ethernet switch on the wall.
5. To remove the wall mount bracket, do the opposite from the steps above.

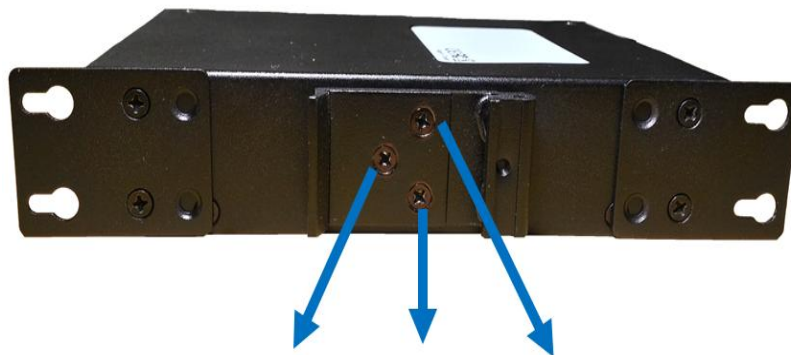

Figure 3.4

Remove DIN-Rail Bracket from the Switch

Below, in *Figure 3.5* are the dimensions of the wall mounting bracket.

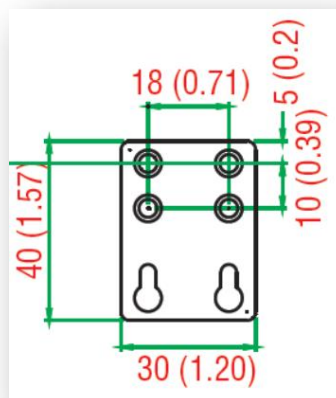

Figure 3.5

Wall Mounting Bracket Dimensions



## 4. Hardware Installation

### 4.1 Installation Steps

This section will explain how to install Antaira Technologies' LNP-0501 (T): 5-port industrial PoE+ unmanaged Ethernet switch with 4\*10/100Tx (30W/port), 1\*100Fx Fiber SC/ST type connector (Multi-mode 2Km, or Single-mode 30Km).

#### Installation Steps

1. Unpack the industrial Ethernet switch from the original packing box.
2. Check if the DIN-Rail bracket is screwed on the industrial Ethernet switch.
  - If the DIN-Rail is not screwed on the industrial Ethernet switch, please refer to the **DIN-Rail Mounting** section for DIN-Rail installation.
  - If there's requiring to wall mount the industrial Ethernet switch, please refer to the **Wall Mounting** section for wall mounting installation.
3. To hang the industrial Ethernet switch on a DIN-Rail or wall, please refer to the **Mounting Installation** section.
4. Power on the industrial Ethernet switch and then the power LED light will turn on.
  - For the help on how to wire power, please refer to the **Wiring the Power Inputs** section.
  - Please refer to the **LED Indicators** section for LED light indication.
5. Prepare the twisted-pair, straight-through category 5 cable for Ethernet connection.
6. Insert one side of the RJ-45 cable into switch's Ethernet port and on the other side into the networking device's Ethernet port, e.g. switch PC or server.
  - The Ethernet port's (RJ-45) LED on the industrial Ethernet switch will turn on when the cable is connected to the networking device.
  - Please refer to the **LED Indicators** section for LED light indication.
7. When all connections are set and the LED lights all show normal, the installation is complete.

## 5. Network Application

This segment provides an example of an industrial Ethernet switch application (*Figure 5.1*).

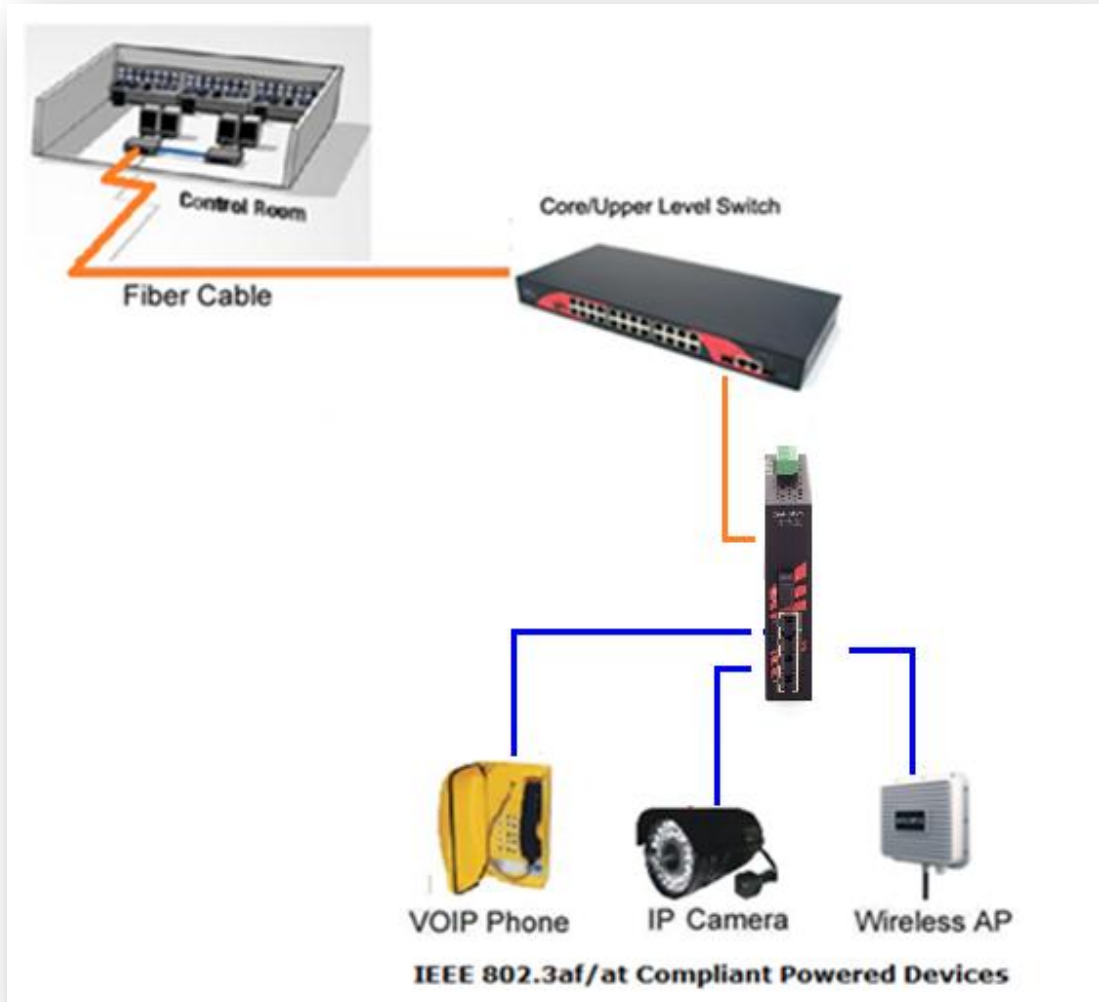

*Figure 5.1*

*Industrial PoE Ethernet Switch Application Reference*

## 6. Trouble Shooting

- Always verify to have the right power cord or adapter. Never use a power supply or adapter with a non-compliant DC output voltage or it will burn the equipment.
- Select the proper UTP or STP cable in order to construct the network. Use an unshielded twisted-pair (UTP) or shield twisted-pair (STP) cable for RJ-45 connections: 100Ω Category 5e for 10M/100Mbps. Also be sure that the length of any twisted-pair connection does not exceed 100 meters (328 feet).
- **Diagnosing LED Indicators:** To assist in identifying problems, the switch can be easily monitored with the LED indicators which help to identify if any problems exist.
  - Please refer to the LED Indicators section for LED light indication.
- If the power indicator LED does not turn on when the power cord is plugged in, the user may have a problem with the power cord. Check for loose power connections, power losses or surges at the power outlet.
  - Please contact Antaira for technical support service, if the problem still cannot be resolved.
- If the industrial switch LED indicators are normal and the connected cables are correct but the packets still cannot transmit, please check the system's Ethernet devices' configuration or status.

## 7. Technical Specifications

Table 7.1 has the technical specifications for Antaira Technologies LNP-0501 series: 5-port industrial PoE+ unmanaged Ethernet switch with 4\*10/100Tx (30W/port), 1\*100Fx Fiber SC/ST type connector (Multi-mode 2Km, or Single-mode 30Km)

<b>Standard</b>	IEEE 802.3 10Base-T Ethernet IEEE 802.3u 100Base-TX Fast Ethernet IEEE802.3x Flow Control and Back Pressure IEEE802.3at Power over Ethernet
<b>Protocol</b>	CSMA/CD
<b>Transfer Rate</b>	14,880pps for Ethernet port 148,800pps for Fast Ethernet port
<b>Transmission Distance</b>	Up to 100M for each Fast Ethernet port Up to 2Km for Multi-mode Fiber port; or Up to 30Km for Single-mode Fiber port.
<b>MAC Address</b>	2K Table Size
<b>RJ45 (Ethernet) Port</b>	4*10/100Tx (30W/Port) auto negotiation speed, full/half duplex mode, and auto MDI/MDI-X connection
<b>PoE Pin Assignment</b>	RJ-45 port #1 ~ # 4 support IEEE 802.3at end-point, alternative A mode. Positive (VCC+): Pin 1, 2 Negative (VCC-): RJ-45 pin 3, 6 Data: Pin 1, 2, 3, 6
<b>Fiber Port</b>	1*100Fx SC/ST type connector: Multi-mode (2Km) or Single-mode (30Km)
<b>LED</b>	<b>Per unit:</b> Power1(Green), Power2(Green), Fault(Red) <b>Per port:</b> Link/Activity (Green) <b>PoE:</b> Feeding Power (Green)
<b>Network Cable</b>	10BaseT: 2-pair UTP/STP Cat. 3, 4, 5 cable EIA/TIA-568 100-ohm (100m) 100BaseTX: 2-pair UTP/STP Cat. 5 cable EIA/TIA-568 100-ohm (100m)
<b>Over Current Protection</b>	Single-Blown Fuse
<b>Power Input</b>	Redundant power DC 48~55V with connective 1*6-pin removable terminal block

<b>Fault Output</b>	1 Relay output
<b>Max Power Consumption</b>	110W@48VDC; 130W@51~55VDC
<b>Installation</b>	DIN-Rail mounting, wall mounting (optional)
<b>Operating Temperature</b>	Standard: -10°C to 70°C (14° to 158° F) EOT: -40°C to 75°C (-40° to 167° F)
<b>Operating Humidity</b>	5% to 95% (Non-Condensing)
<b>Storage Temperature</b>	-40°C to 85°C (-40°F ~ 185°F)
<b>Case Dimension</b>	IP-30, 30mm (W) x 99mm (D) x 142mm (H)
<b>EMI</b>	FCC Class A IEC61000-4-2/3/4/5/6/8 IEC61000-6-2 IEC61000-6-4
<b>Stability Testing</b>	IEC60068-2-32 (Free fall) IEC60068-2-27 (Shock) IEC60068-2-6 (Vibration)
<b>Safety</b>	UL 508, ISA 12.12.01

Table 7.1

## LNP-0501 Series Technical Specifications

**Antaira Customer Service and Support**

(Antaira US Headquarter) + 844-268-2472

(Antaira Europe Office) + 48-22-862-88-81

(Antaira Asia Office) + 886-2-2218-9733

**Please report any problems to Antaira:**[www.antaira.com](http://www.antaira.com) / [support@antaira.com](mailto:support@antaira.com)[www.antaira.eu](http://www.antaira.eu) / [info@antaira.eu](mailto:info@antaira.eu)[www.antaira.com.tw](http://www.antaira.com.tw) / [info@antaira.com.tw](mailto:info@antaira.com.tw)

Any changes to this material will be announced on the Antaira website.